

FORMS PRESS, INC.
STOCK TAGS &
LABELS

September 2019



forms
PRESS
INC.

Conditions & Guidelines

- We accept Visa, MasterCard and American Express. A 2.5% credit card fee is applied to an invoices over \$5,000.
- \$50 minimum order. Items can be combined to meet the \$50 minimum order requirements.
- Returns: \$30 restocking fee or 20%, whichever is greater. No returns after 90 days from invoice date. No returns without authorization from factory. Prices subject to change without notice.
- RFID is subject to a 40% restocking fee.
- If we don't have enough inventory to complete an order, Forms Press is not responsible for additional freight costs.
- Returned merchandise must be in saleable condition.
- Last column pricing is achieved by meeting the dollar amount for each individual item. Items cannot be combined to achieve last column pricing.
- Stock laser sheet labels - packages of 100 cannot be broken.
- \$15 Handling fee for less than case quantities.
- \$7.50 Handling fee per ship to address for more than 3 locations.
- All stock labels are available perfed or non-perfed upon request at the same price listed in our catalog, but are nonreturnable. Some stock items may be discontinued. Contact your customer service representative for lead times. Note: Lead time could be up to two weeks for non-stock items.
- **Rework of Stock Labels to different size core and/or quantity per roll:**
 - 1) Limited to one case, per quarter, per size
 - 2) No more than 100 finished rolls
 - 3) Lead time could be up to 10 working days
 - 4) Reworks of rolls to fanfold could result in leaning stacks
 - 5) Cost: a flat \$75 fee plus the cost of labels
 - RFID: a flat \$100 fee plus the cost of labels
 - Broken case fee still applies
 - Reworks must divide equally from original roll or stack. If alternative quantity is requested, the entire roll or stack quantity will be billed
 - 6) Reworked product cannot be returned
- **Cancellation Fee:** Due to the customized process of each order, Forms Press is subject to charge a minimum of \$50, depending on the stage of order.

10 Business Days Lead Time

Shaded items may be in stock, but have a lower demand. These items could potentially have a lead time of 10 business days. It might take a few days, but you'll still receive great stock pricing!

In the event a stock order is larger than our normal demand, partial shipment will be available, but the full order could possibly have a longer lead time.

Placing Orders

- To minimize errors, please fax or email your order. Verbal orders are not accepted.
- All order changes, including shipping instructions, must be confirmed in writing.
- Custom orders are subject to a +/- 10% variance.
- Stock orders, requesting to ship same day, must be faxed or emailed no later than 12:00 PM EST.
- Submission of orders infers that product has been tested and accepted in actual end-user environment.

Definitions

Visible Light - Most common technology, used with standard direct thermal chemistry.

Near IR - Dyes added to absorb light at 670 - 700 nm. Designed to filter out minor amounts of contaminants. Used in the Parcel Tracking Industry.

Non-Topcoated Direct Thermal – This material is an uncoated medium sensitivity product with excellent image quality with a permanent acrylic adhesive. Because this material is uncoated, it should be tested by the end user before ordering large quantities. This product should not be used in applications that require extreme environmental resistance.

Topcoated Direct Thermal – This material is a topcoated, medium sensitivity product with an acrylic permanent adhesive. This material has excellent image quality and it provides excellent results in most environmental conditions. We recommend that any direct thermal material be tested in an end-user application before ordering large quantities.

How to Read Forms Press Part Numbers

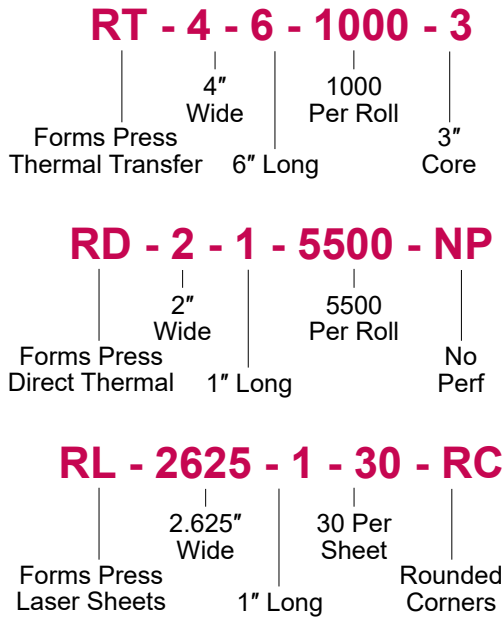

How Sheeted Labels Are Packaged

Laser Sheets:

- 100 sheets are in a pack
- 10 packs are in a case
- Total = 1,000 sheets per case

Integrated Labels:

- 250 sheets per chipboard lift
- 6 lifts are in 1 poly bag per case
- Total=1,500 sheets per case

Integrated Cards:

- 200 sheets per inner box
- 5 inner boxes per case
- Total=1,000 sheets per case

Table of Contents

Thermal Transfer Labels 2-5

Thermal Transfer Fanfold Stacks..... 5

Thermal Transfer Tags.....5

Thermal Transfer Specialty Materials.....6

Floodcoated Thermal Transfer Labels..... 6-8

Fluorescent Floodcoated Thermal Transfer Labels 8-9

Horizontal Color Bar Thermal Transfer Labels..... 9

Thermal Transfer Circles.....10

RFID Enabled Thermal Transfer Labels11

Direct Thermal Labels 12-15

Direct Thermal Shipping System Labels..... 15-16

Direct Thermal Fanfold Labels & Tags.....16

Dymo Compatible Direct Thermal Labels..... 17

Floodcoated Direct Thermal Labels 18-19

Liner-free Repositionable Direct Thermal Rolls 20

Inkjet Labels for Epson Color Works Printers.....21-22

Laser Sheets..... 23-25

Integrated Label Sheets26-29

Handling Labels 30

Inventory Control Labels31-32

Made in the U.S.A. Labels.....33

Label Accessories 34-36

Forms Press' Portfolio of Products 37

Thermal Transfer Labels

Part #	Width	Length	Number Up	Core Size	Labels / Roll	Approx Wt / Case	Rolls / Case	Stocking Locations
--------	-------	--------	-----------	-----------	---------------	------------------	--------------	--------------------

12" O. D. Topcoated Thermal Transfer, Permanent Adhesive, No Perf, Wound Out, 3" Core

10 business days	RT-4-2-7595-NP	4	2	1	3	7595	45	3	OH, AZ
	RT-4-3-5164-NP	4	3	1	3	5164	43	3	OH
	RT-4-6-2800-NP	4	6	1	3	2800	51	3	OH, AZ

8" O.D. Topcoated Thermal Transfer, Permanent Adhesive, Perfed Each, Wound Out, 3" Core

10 business days	RT-1-05-19200-3	1	0.5	2	3	19,200	21	8	OH
	RT-1-075-7500-3	1	0.75	1	3	7500	12	8	OH
	RT-1-1-5500-3	1	1	1	3	5500	12	8	OH, AZ
10 business days	RT-1-2-2900-3	1	2	1	3	2900	12	8	OH
	RT-1-3-1900-3	1	3	1	3	1900	12	8	OH
	RT-1-4-1500-3	1	4	1	3	1500	12	8	OH
10 business days	RT-125-05-9600-3	1.25	0.5	1	3	9600	14	8	OH, AZ
	RT-15-05-9600-3	1.5	0.5	1	3	9600	16	8	OH
	RT-15-075-15000-3	1.5	0.75	2	3	15,000	18	4	OH, AZ
	RT-15-075-7500-3	1.5	0.75	1	3	7500	18	8	OH, AZ
	RT-15-1-5500-3	1.5	1	1	3	5500	18	8	OH, AZ
	RT-15-1-10000-3	1.5	1	2	3	10,000	16	4	OH, AZ
	RT-15-125-4450-3	1.5	1.25	1	3	4450	19	8	OH
	RT-15-15-3600-3	1.5	1.5	1	3	3600	17	8	OH, AZ
	RT-15-15-7200-3	1.5	1.5	2	3	7200	16	4	OH, AZ
	RT-15-2-2900-3	1.5	2	1	3	2900	18	8	OH, AZ
10 business days	RT-175-25-2500-3	1.75	2.5	1	3	2500	22	8	OH
	RT-2-05-9600-3	2	0.5	1	3	9600	20	8	OH
	RT-2-075-7500-3	2	0.75	1	3	7500	23	8	OH
10 business days	RT-2-1-5500-3	2	1	1	3	5500	23	8	OH, AZ
	RT-2-1-11000-3	2	1	2	3	11,000	23	4	OH, AZ
	RT-2-125-4450-3	2	1.25	1	3	4450	22	8	OH
	RT-2-15-3600-3	2	1.5	1	3	3600	22	8	OH, AZ
10 business days	RT-2-15-7200-3	2	1.5	2	3	7200	20	4	OH, AZ
	RT-2-2-2900-3	2	2	1	3	2900	24	8	OH, AZ
	RT-2-2-2900-NP	2	2	1	3	2900	24	8	OH, AZ
	RT-2-3-1900-3	2	3	1	3	1900	23	8	OH
	RT-2-4-1500-3	2	4	1	3	1500	24	8	OH
	RT-2-5-1200-3	2	5	1	3	1200	23	8	OH
10 business days	RT-225-075-7500-3	2.25	0.75	1	3	7500	26	8	OH
	RT-225-125-4450-3	2.25	1.25	1	3	4450	25	8	OH, AZ
	RT-225-2-2900-3	2.25	2	1	3	2900	26	8	OH
10 business days	RT-25-1-5500-3	2.5	1	1	3	5500	29	8	OH, AZ
	RT-25-15-3600-3	2.5	1.5	1	3	3600	26	8	OH, AZ
	RT-25-2-2900-3	2.5	2	1	3	2900	29	8	OH
	RT-25-25-2500-3	2.5	2.5	1	3	2500	30	8	OH
10 business days	RT-275-07-5340-3	2.75	0.7	1	3	5340	26	8	OH
	RT-275-125-4450-3	2.75	1.25	1	3	4450	29	8	OH
	RT-3-075-7500-3	3	0.75	1	3	7500	34	8	OH

Part #	Width	Length	Number Up	Core Size	Labels / Roll	Approx Wt / Case	Rolls / Case	Stocking Locations
8" O.D. Topcoated Thermal Transfer, Permanent Adhesive, Perfed Each, Wound Out, 3" Core (continued)								
RT-3-1-5500-3	3	1	1	3	5500	33	8	OH, AZ
RT-3-15-3600-3	3	1.5	1	3	3600	32	8	OH, AZ
RT-3-2-3000-3	3	2	1	3	3000	34	8	OH, AZ
RT-3-3-2000-3	3	3	1	3	2000	35	8	OH, AZ
RT-3-35-1700-3	3	3.5	1	3	1700	34	8	OH
RT-3-4-1500-3	3	4	1	3	1500	36	8	OH
RT-3-5-1200-3	3	5	1	3	1200	35	8	OH, AZ
RT-3-6-1000-3	3	6	1	3	1000	34	8	OH
RT-3125-5-1180-3	3.125	5	1	3	1180	36	8	OH
RT-325-2-2900-3	3.25	2	1	3	2900	N/A	8	OH
RT-35-1-5500-3	3.5	1	1	3	5500	20	4	OH, AZ
RT-35-15-3600-3	3.5	1.5	1	3	3600	19	4	OH, AZ
RT-35-2-3000-3	3.5	2	1	3	3000	20	4	OH, AZ
RT-35-25-2500-3	3.5	2.5	1	3	2500	21	4	OH
RT-35-5-1200-3	3.5	5	1	3	1200	21	4	OH
RT-35-8-750-3	3.5	8	1	3	750	20	4	OH
RT-4-1-5500-3	4	1	1	3	5500	23	4	OH, AZ
RT-4-15-3600-3	4	1.5	1	3	3600	21	4	OH, AZ
RT-4-2-2900-3	4	2	1	3	2900	23	4	OH, AZ
RT-4-2-2900-NP	4	2	1	3	2900	23	4	OH, AZ
RT-4-225-2575-3	4	2.25	1	3	2575	22	4	OH
RT-4-25-2500-3	4	2.5	1	3	2500	26	4	OH, AZ
RT-4-3-1900-3	4	3	1	3	1900	22	4	OH, AZ
RT-4-3-1900-NP	4	3	1	3	1900	22	4	OH, AZ
RT-4-4-1500-3	4	4	1	3	1500	23	4	OH, AZ
RT-4-5-1200-3	4	5	1	3	1200	22	4	OH
RT-4-6-1000-3	4	6	1	3	1000	24	4	OH, AZ
RT-4-6-1000-NP	4	6	1	3	1000	24	4	OH, AZ
RT-4-65-900-3	4	6.5	1	3	900	23	4	OH, AZ
RT-4-8-750-3	4	8	1	3	750	24	4	WI
RT-4-10-600-3	4	10	1	3	600	22	4	OH
RT-4-12-500-3	4	12	1	3	500	23	4	OH
RT-4-13-450-3	4	13	1	3	450	24	4	OH
RT-45-25-2500-3	4.5	2.5	1	3	2500	30	4	OH
RT-45-3-1900-3	4.5	3	1	3	1900	24	4	OH
RT-45-45-1400-3	4.5	4.5	1	3	1400	27	4	OH
RT-45-5-1200-3	4.5	5	1	3	1200	26	4	OH
RT-45-6-995-3	4.5	6	1	3	995	26	4	OH
RT-5-25-2500-3	5	2.5	1	3	2500	30	4	OH
RT-5-3-1900-3	5	3	1	3	1900	28	4	OH, AZ
RT-5-4-1500-3	5	4	1	3	1500	30	4	OH
RT-5-8-750-3	5	8	1	3	750	28	4	OH
RT-6-4-1500-3	6	4	1	3	1500	35	4	OH, AZ
RT-6-6-1000-3	6	6	1	3	1000	38	4	OH
RT-6-8-750-3	6	8	1	3	750	34	4	OH
RT-65-4-1500-3	6.5	4	1	3	1500	36	4	OH
RT-85-6-1000-3	8.5	6	1	3	1000	50	4	OH

10 business days

10 business days

10 business days

10 business days

10 business days

10 business days

10 business days

10 business days

10 business days

10 business days

10 business days

Shaded items have a lead time of ten business days.

Part #	Width	Length	Number Up	Core Size	Labels / Roll	Approx Wt / Case	Rolls / Case	Stocking Locations
--------	-------	--------	-----------	-----------	---------------	------------------	--------------	--------------------

8" O.D. Topcoated Thermal Transfer Continuous Roll, Permanent Adhesive, No Perf, Wound Out, 3" Core

10 business days	RT-4-500-1-3*	4	500'	1	3	1	23	4	OH
------------------	---------------	---	------	---	---	---	----	---	----

* This item's price is per roll. Continuous roll of material that is 4 inches wide and 500 feet long. Liner is slit down middle for easy removal.

8" O.D. Topcoated Thermal Transfer, Permanent Adhesive, Perfed Each, Wound In, 3" Core

RT-4-6-1000-IN	4	6	1	3	1000	24	4	OH
----------------	---	---	---	---	------	----	---	----

8" O.D. Removable Adhesive, Topcoated Thermal Transfer, Perfed Each, Wound Out, 3" Core

10 business days	RE-15-1-5500-3	1.5	1	1	3	5500	18	8	OH
	RE-2-1-5500-3	2	1	1	3	5500	33	8	OH
	RE-3-1-5500-3	3	1	1	3	5500	33	8	OH
	RE-3-5-1200-3	3	5	1	3	1200	35	8	OH
10 business days	RE-35-15-3600-3	3.5	1.5	1	3	3600	19	4	OH
	RE-4-1-5500-3	4	1	1	3	5500	23	4	OH
10 business days	RE-4-2-2900-3	4	2	1	3	2900	23	4	OH
	RE-4-3-1900-3	4	3	1	3	1900	22	4	OH
	RE-4-4-1500-3	4	4	1	3	1500	23	4	OH
	RE-4-6-1000-3	4	6	1	3	1000	24	4	OH, AZ

6" O.D. Topcoated Thermal Transfer, Permanent Adhesive, Perfed Each, Wound Out, 3" Core

10 business days	RT-3-2-1475-3	3	2	1	3	1475	20	8	OH
	RT-4-3-975-3	4	3	1	3	975	26	8	OH
	RT-4-4-750-3	4	4	1	3	750	24	8	OH
	RT-4-6-525-3	4	6	1	3	525	26	8	OH

5" O.D. Topcoated Thermal Transfer, Permanent Adhesive, Perfed Each, Wound Out, 1" Core

10 business days	RT-2-1-2500-1	2	1	1	1	2500	16	12	OH
	RT-225-125-2100-1	2.25	1.25	1	1	2100	19	12	OH
	RT-25-1-2500-1	2.5	1	1	1	2500	30	12	OH
	RT-3-1-2500-1	3	1	1	1	2500	23	12	OH
10 business days	RT-3-3-890-1	3	3	1	1	890	24	12	OH
	RT-35-1-2500-1	3.5	1	1	1	2500	27	12	OH
	RT-4-1-2500-1	4	1	1	1	2500	30	12	OH
	RT-4-15-1800-1	4	1.5	1	1	1800	30	12	OH
10 business days	RT-4-2-1320-1	4	2	1	1	1320	32	12	OH
	RT-4-3-890-1	4	3	1	1	890	31	12	OH
	RT-4-4-700-1	4	4	1	1	700	33	12	OH
	RT-4-6-460-1	4	6	1	1	460	33	12	OH
10 business days	RT-4-65-380-1	4	6.5	1	1	380	29	12	OH

4" O.D. Topcoated Thermal Transfer, Permanent Adhesive, Perfed Each, Wound Out, 1" Core

10 business days	RT-15-1-1375-1	1.5	1	1	1	1375	7	12	OH
	RT-2-1-1375-1	2	1	1	1	1375	9	12	OH
	RT-225-125-1135-1	2.25	1.25	1	1	1135	10	12	OH
10 business days	RT-225-2-735-1	2.25	2	1	1	735	10	12	OH
	RT-25-1-1375-1	2.5	1	1	1	1375	12	12	OH
	RT-3-1-1375-1	3	1	1	1	1375	14	12	AZ, WI
	RT-3-2-735-1	3	2	1	1	735	13	12	OH

Part #	Width	Length	Number Up	Core Size	Labels / Roll	Approx Wt / Case	Rolls / Case	Stocking Locations
--------	-------	--------	-----------	-----------	---------------	------------------	--------------	--------------------

4" O.D. Topcoated Thermal Transfer, Permanent Adhesive, Perfed Each, Wound Out, 1" Core (continued)

RT-3-3-500-1	3	3	1	1	500	13	12	OH	10 business days
RT-3-5-300-1	3	5	1	1	300	13	12	OH	
RT-3-5-1-1375-1	3.5	1	1	1	1375	16	12	OH	
RT-4-1-1375-1	4	1	1	1	1375	17	12	OH	10 business days
RT-4-15-960-1	4	1.5	1	1	960	17	12	OH, AZ	
RT-4-2-735-1	4	2	1	1	735	18	12	OH	
RT-4-3-500-1	4	3	1	1	500	18	12	AZ, WI	10 business days
RT-4-4-380-1	4	4	1	1	380	18	12	OH	
RT-4-6-250-1	4	6	1	1	250	17	12	AZ, WI	
RT-4-65-230-1	4	6.5	1	1	230	17	12	OH	10 business days

4" O.D. Removable Adhesive, Topcoated Thermal Transfer, Perfed Each, Wound Out, 1" Core

RE-2-1-1375-1	2	1	1	1	1375	10	12	OH	10 business days
RE-225-125-1135-1	2.25	1.25	1	1	1135	11	12	OH	
RE-3-1-1375-1	3	1	1	1	1375	14	12	OH	
RE-4-1-1375-1	4	1	1	1	1375	19	12	OH	10 business days
RE-4-15-960-1	4	1.5	1	1	960	19	12	OH	
RE-4-2-735-1	4	2	1	1	735	19	12	OH	
RE-4-6-250-1	4	6	1	1	250	20	12	OH	

Thermal Transfer Fanfold Stacks

Part #	Width	Length	Labels / Fold	FF= Fanfold	Labels / Stack	Approx Wt / Case	Labels / Case	Stocking Locations
--------	-------	--------	---------------	-------------	----------------	------------------	---------------	--------------------

Fanfold Stacks, Topcoated Thermal Transfer, Permanent Adhesive, Perfed Each

RT-3-2-7500-FF	3	2	5	FF	7500	22	15,000	OH	10 business days
RT-3-5-1250-FF	3	5	2	FF	1250	10	2500	OH	
RT-4-1-10500-FF	4	1	10	FF	10,500	22	21,000	OH	
RT-4-15-3600-FF	4	1.5	7	FF	3600	N/A	7200	OH	10 business days
RT-4-2-2500-FF	4	2	5	FF	2500	10	5000	OH	
RT-4-3-2500-FF	4	3	4	FF	2500	14	5000	OH	
RT-4-4-2500-FF	4	4	3	FF	2500	18	5000	OH	10 business days
RT-4-6-2000-FF	4	6	2	FF	2000	22	4000	OH, AZ	
RT-4-65-2000-FF	4	6.5	2	FF	2000	24	4000	OH	
RT-4-8-1000-FF	4	8	1	FF	1000	20	2000	OH	10 business days
RT-6-4-1500-FF	6	4	3	FF	1500	18	3000	OH	

Thermal Transfer Tags

Part #	Width	Length	Tags / Fold	FF= Fanfold	Tags / Stack	Approx Wt / Case	Tags / Case	Stocking Locations
--------	-------	--------	-------------	-------------	--------------	------------------	-------------	--------------------

7 pt. Thermal Transfer C1S Tag Stock (Notches at Perf for Sensing), Fanfold

RTAG-3-15-4000-FF *	3	1.5	7	FF	4000	10	8000	OH
RTAG-4-3-2000-FF	4	3	4	FF	2000	14	4000	OH
RTAG-4-6-1000-FF	4	6	2	FF	1000	24	4000	OH
RTAG-4-65-1000-FF	4	6.5	2	FF	1000	28	4000	OH

* Tags with Horseshoe Hang Hole. See illustration on page 9.

Shaded items have a lead time of ten business days.

Thermal Transfer Specialty Materials

Part #	Width	Length	Number Up	Core Size	Labels / Roll	Approx Wt / Case	Rolls / Case	Stocking Locations
--------	-------	--------	-----------	-----------	---------------	------------------	--------------	--------------------

8" O.D. Hammerlock Adhesive (*very aggressive*), Topcoated Thermal Transfer, Perfed Each, Wound Out, 3" Core

10 business days	RH-4-2-2900-3	4	2	1	3	2900	25	4	OH
	RH-4-6-1000-3	4	6	1	3	1000	26	4	OH

8" O.D. Smudge Proof Kimdura, Permanent Adhesive, Perfed Each, Wound Out, 3" Core

10 business days	RK-2-1-5150-3	2	1	1	3	5150	22	8	OH
	RK-4-2-2730-3	4	2	1	3	2730	22	4	OH
	RK-4-6-950-3	4	6	1	3	950	28	4	OH

8" O.D. Matte Polypropylene Film (Synthetic), Permanent Adhesive, Perfed Each, Wound Out, 3" Core

10 business days	RSP-2-1-5150-3	2	1	1	3	5150	22	8	OH
	RSP-3-2-2750-3	3	2	1	3	2750	30	8	OH
	RSP-4-2-2730-3	4	2	1	3	2730	22	4	OH
	RSP-4-3-2000-3	4	3	1	3	2000	22	4	OH
	RSP-4-4-1500-3	4	4	1	3	1500	22	4	OH
	RSP-4-6-950-3	4	6	1	3	950	28	4	OH
	RSP-4-6.5-950-3	4	6.5	1	3	950	22	4	OH

8" O.D. 2 Mil. White Gloss Polyester, Permanent Adhesive, Perfed Each, Wound Out, 3" Core

10 business days	RP-15-075-7500-3	1.5	0.75	1	3	7500	20	8	OH
	RP-15-075-15000-3	1.500	0.75	2	3	15,000	20	4	OH
	RP-175-05-10000-3	1.75	0.5	1	3	10,000	22	8	OH
	RP-175-05-10000-NP	1.75	0.5	1	3	10,000	22	8	OH
10 business days	RP-2-1-5000-3	2	1	1	3	5000	22	8	OH
	RP-2-1-5000-NP	2	1	1	3	5000	22	8	OH
10 business days	RP-3-1-5000-3	3	1	1	3	5000	34	8	OH
	RP-3-2-3000-3	3	2	1	3	3000	22	4	OH
	RP-4-1-5000-3	4	1	1	3	5000	26	4	OH
	RP-4-2-3000-3	4	2	1	3	3000	28	4	OH
	RP-4-6-1050-3	4	6	1	3	1050	28	4	OH

Floodcoated Thermal Transfer Labels

Part #	Color	Width	Length	Number Up	Core Size	Labels / Roll	Approx Wt / Case	Rolls / Case	Stocking Locations
--------	-------	-------	--------	-----------	-----------	---------------	------------------	--------------	--------------------

8" O.D. Floodcoated Thermal Transfer, Permanent Adhesive, Perfed Each, Wound Out, 3" Core

10 business days	RFC-2-1-5500-YL	Yellow	2	1	1	3	5500	23	8	OH
	RFC-2-1-5500-PK	Pink	2	1	1	3	5500	23	8	OH
	RFC-2-1-5500-RD	Red	2	1	1	3	5500	23	8	OH
	RFC-2-1-5500-BL	Blue	2	1	1	3	5500	23	8	OH
	RFC-2-1-5500-GR	Green	2	1	1	3	5500	23	8	OH
	RFC-2-1-5500-OR	Orange	2	1	1	3	5500	23	8	OH
	RFC-2-3-1900-YL	Yellow	2	3	1	3	1900	23	8	OH
	RFC-2-3-1900-PK	Pink	2	3	1	3	1900	23	8	OH
	RFC-2-3-1900-RD	Red	2	3	1	3	1900	23	8	OH

Part #	Color	Width	Length	Number Up	Core Size	Labels / Roll	Approx Wt / Case	Rolls / Case	Stocking Locations
--------	-------	-------	--------	-----------	-----------	---------------	------------------	--------------	--------------------

8" O.D. Floodcoated Thermal Transfer, Permanent Adhesive, Perfed Each, Wound Out, 3" Core (continued)

RFC-2-3-1900-BL	Blue	2	3	1	3	1900	23	8	OH	10 business days
RFC-2-3-1900-GR	Green	2	3	1	3	1900	23	8	OH	
RFC-2-3-1900-OR	Orange	2	3	1	3	1900	23	8	OH	
RFC-3-1-5500-YL	Yellow	3	1	1	3	5500	33	8	OH	10 business days
RFC-3-1-5500-PK	Pink	3	1	1	3	5500	33	8	OH	
RFC-3-1-5500-RD	Red	3	1	1	3	5500	33	8	OH	
RFC-3-1-5500-BL	Blue	3	1	1	3	5500	33	8	OH	
RFC-3-1-5500-GR	Green	3	1	1	3	5500	33	8	OH	
RFC-3-1-5500-OR	Orange	3	1	1	3	5500	33	8	OH	
RFC-3-2-2900-YL	Yellow	3	2	1	3	2900	33	8	OH	
RFC-3-2-2900-PK	Pink	3	2	1	3	2900	33	8	OH	
RFC-3-2-2900-RD	Red	3	2	1	3	2900	33	8	OH	
RFC-3-2-2900-BL	Blue	3	2	1	3	2900	33	8	OH	10 business days
RFC-3-2-2900-GR	Green	3	2	1	3	2900	33	8	OH	
RFC-3-2-2900-OR	Orange	3	2	1	3	2900	33	8	OH	
RFC-4-1-5500-YL	Yellow	4	1	1	3	5500	23	4	OH	10 business days
RFC-4-1-5500-PK	Pink	4	1	1	3	5500	23	4	OH	
RFC-4-1-5500-RD	Red	4	1	1	3	5500	23	4	OH	
RFC-4-1-5500-BL	Blue	4	1	1	3	5500	23	4	OH	
RFC-4-1-5500-GR	Green	4	1	1	3	5500	23	4	OH	
RFC-4-1-5500-OR	Orange	4	1	1	3	5500	23	4	OH	
RFC-4-2-2900-YL	Yellow	4	2	1	3	2900	23	4	OH	
RFC-4-2-2900-PK	Pink	4	2	1	3	2900	23	4	OH	
RFC-4-2-2900-RD	Red	4	2	1	3	2900	23	4	OH	
RFC-4-2-2900-BL	Blue	4	2	1	3	2900	23	4	OH	10 business days
RFC-4-2-2900-GR	Green	4	2	1	3	2900	23	4	OH	
RFC-4-2-2900-OR	Orange	4	2	1	3	2900	23	4	OH	
RFC-4-3-1900-YL	Yellow	4	3	1	3	1900	24	4	OH	10 business days
RFC-4-3-1900-PK	Pink	4	3	1	3	1900	24	4	OH	
RFC-4-3-1900-RD	Red	4	3	1	3	1900	24	4	OH	
RFC-4-3-1900-BL	Blue	4	3	1	3	1900	24	4	OH	
RFC-4-3-1900-GR	Green	4	3	1	3	1900	24	4	OH	
RFC-4-3-1900-OR	Orange	4	3	1	3	1900	24	4	OH	
RFC-4-4-1500-YL	Yellow	4	4	1	3	1500	23	4	OH	10 business days
RFC-4-4-1500-PK	Pink	4	4	1	3	1500	23	4	OH	
RFC-4-4-1500-RD	Red	4	4	1	3	1500	23	4	OH	
RFC-4-4-1500-BL	Blue	4	4	1	3	1500	23	4	OH	
RFC-4-4-1500-GR	Green	4	4	1	3	1500	23	4	OH	
RFC-4-4-1500-OR	Orange	4	4	1	3	1500	23	4	OH	
RFC-4-6-1000-YL	Yellow	4	6	1	3	1000	24	4	OH	10 business days
RFC-4-6-1000-PK	Pink	4	6	1	3	1000	24	4	OH	
RFC-4-6-1000-RD	Red	4	6	1	3	1000	24	4	OH	
RFC-4-6-1000-BL	Blue	4	6	1	3	1000	24	4	OH	
RFC-4-6-1000-GR	Green	4	6	1	3	1000	24	4	OH	
RFC-4-6-1000-OR	Orange	4	6	1	3	1000	24	4	OH	
RFC-4-65-900-YL	Yellow	4	6.5	1	3	900	23	4	OH	10 business days

Shaded items have a lead time of ten business days.

Part #	Color	Width	Length	Number Up	Core Size	Labels / Roll	Approx Wt / Case	Rolls / Case	Stocking Locations
--------	-------	-------	--------	-----------	-----------	---------------	------------------	--------------	--------------------

8" O.D. Floodcoated Thermal Transfer, Permanent Adhesive, Perfed Each, Wound Out, 3" Core (continued)

10 business days

RFC-4-65-900-PK	Pink	4	6.5	1	3	900	23	4	OH
RFC-4-65-900-RD	Red	4	6.5	1	3	900	23	4	OH
RFC-4-65-900-BL	Blue	4	6.5	1	3	900	23	4	OH
RFC-4-65-900-GR	Green	4	6.5	1	3	900	23	4	OH
RFC-4-65-900-OR	Orange	4	6.5	1	3	900	23	4	OH
RFC-4-8-750-YL	Yellow	4	8	1	3	750	24	4	OH
RFC-4-8-750-PK	Pink	4	8	1	3	750	24	4	OH
RFC-4-8-750-RD	Red	4	8	1	3	750	24	4	OH
RFC-4-8-750-BL	Blue	4	8	1	3	750	24	4	OH
RFC-4-8-750-GR	Green	4	8	1	3	750	24	4	OH
RFC-4-8-750-OR	Orange	4	8	1	3	750	24	4	OH
RFC-6-4-1500-YL	Yellow	6	4	1	3	1500	35	4	OH
RFC-6-4-1500-PK	Pink	6	4	1	3	1500	35	4	OH
RFC-6-4-1500-RD	Red	6	4	1	3	1500	35	4	OH
RFC-6-4-1500-BL	Blue	6	4	1	3	1500	35	4	OH
RFC-6-4-1500-GR	Green	6	4	1	3	1500	35	4	OH
RFC-6-4-1500-OR	Orange	6	4	1	3	1500	35	4	OH

PMS Colors: Pantone Yellow, 176 Pink, 032 Red, 290 Blue, 345 Green, 1495 Orange

4" O.D. Floodcoated Thermal Transfer, Permanent Adhesive, Perfed Each, Wound Out, 1" Core

10 business days

RFC-2-3-500-YL	Yellow	2	3	1	1	500	9	12	OH
RFC-2-3-500-RD	Red	2	3	1	1	500	9	12	OH
RFC-2-3-500-BL	Blue	2	3	1	1	500	9	12	OH
RFC-2-3-500-GR	Green	2	3	1	1	500	9	12	OH
RFC-2-3-500-OR	Orange	2	3	1	1	500	9	12	OH
RFC-3-1-1375-YL	Yellow	3	1	1	1	1375	14	12	OH
RFC-3-1-1375-RD	Red	3	1	1	1	1375	14	12	OH
RFC-3-1-1375-BL	Blue	3	1	1	1	1375	14	12	OH
RFC-3-1-1375-GR	Green	3	1	1	1	1375	14	12	OH
RFC-3-1-1375-OR	Orange	3	1	1	1	1375	14	12	OH
RFC-4-6-250-YL	Yellow	4	6	1	1	250	17	12	OH
RFC-4-6-250-RD	Red	4	6	1	1	250	17	12	OH
RFC-4-6-250-BL	Blue	4	6	1	1	250	17	12	OH
RFC-4-6-250-GR	Green	4	6	1	1	250	17	12	OH
RFC-4-6-250-OR	Orange	4	6	1	1	250	17	12	OH

PMS Colors: Pantone Yellow, 032 Red, 290 Blue, 345 Green, 1495 Orange

Fluorescent Floodcoated Thermal Transfer Labels

Part #	Color	Width	Length	Nbr Up	Core Size	Labels / Roll	Approx Wt / Case	Rolls / Case	Stocking Locations
--------	-------	-------	--------	--------	-----------	---------------	------------------	--------------	--------------------

8" O.D. Fluorescent Floodcoated Thermal Transfer, Permanent Adhesive, Perfed Each, Wound Out, 3" Core

10 business days

FL-2-3-1900-RD	Red	2	3	1	3	1900	23	8	OH
FL-2-3-1900-CH	Chartreuse	2	3	1	3	1900	23	8	OH
FL-2-3-1900-GR	Green	2	3	1	3	1900	23	8	OH
FL-2-3-1900-OR	Orange	2	3	1	3	1900	23	8	OH

Part #	Color	Width	Length	Number Up	Core Size	Labels / Roll	Approx Wt / Case	Rolls / Case	Stocking Locations
--------	-------	-------	--------	-----------	-----------	---------------	------------------	--------------	--------------------

8" O.D. Fluorescent Floodcoated Thermal Transfer, Perm. Adhesive, Perfed Each, Wound Out, 3" Core (continued)

FL-2-3-1900-PK	Pink	2	3	1	3	1900	23	8	OH
FL-3-5-1200-RD	Red	3	5	1	3	1200	35	8	OH
FL-3-5-1200-CH	Chartreuse	3	5	1	3	1200	35	8	OH
FL-3-5-1200-GR	Green	3	5	1	3	1200	35	8	OH
FL-3-5-1200-OR	Orange	3	5	1	3	1200	35	8	OH
FL-3-5-1200-PK	Pink	3	5	1	3	1200	35	8	OH
FL-4-2-2900-RD	Red	4	2	1	3	2900	23	4	OH
FL-4-2-2900-CH	Chartreuse	4	2	1	3	2900	23	4	OH
FL-4-2-2900-GR	Green	4	2	1	3	2900	23	4	OH
FL-4-2-2900-OR	Orange	4	2	1	3	2900	23	4	OH
FL-4-2-2900-PK	Pink	4	2	1	3	2900	23	4	OH
FL-4-3-1900-RD	805 Red	4	3	1	3	1900	22	4	OH
FL-4-3-1900-CH	Chartreuse	4	3	1	3	1900	22	4	OH
FL-4-3-1900-GR	Green	4	3	1	3	1900	22	4	OH
FL-4-3-1900-OR	Orange	4	3	1	3	1900	22	4	OH
FL-4-3-1900-PK	Pink	4	3	1	3	1900	22	4	OH
FL-4-6-1000-RD	Red	4	6	1	3	1000	28	4	OH
FL-4-6-1000-CH	Chartreuse	4	6	1	3	1000	28	4	OH
FL-4-6-1000-GR	Green	4	6	1	3	1000	28	4	OH
FL-4-6-1000-OR	Orange	4	6	1	3	1000	28	4	OH
FL-4-6-1000-PK	Pink	4	6	1	3	1000	28	4	OH

10 business days

PMS Colors: 805 Red, Chartreuse (Yellow-Green), 802 Green, 804 Orange, 806 Pink

Horizontal Color Bar Thermal Transfer Labels

Part #	Tab Color	Width	Length	Number Up	Core Size	Labels / Roll	Approx Wt / Case	Rolls / Case	Stocking Locations
--------	-----------	-------	--------	-----------	-----------	---------------	------------------	--------------	--------------------

8" O.D. 1/2" Horizontal Color Bar at Trailing Edge, Thermal Transfer, Perm Adhes, Perfed Each, Wound Out, 3" Core

RTC-4-65-1000-BL	Blue	4	6.5	1	3	1000	24	4	OH
RTC-4-65-1000-GR	Green	4	6.5	1	3	1000	24	4	OH
RTC-4-65-1000-OR	Orange	4	6.5	1	3	1000	24	4	OH
RTC-4-65-1000-PV	Violet	4	6.5	1	3	1000	24	4	OH

10 business days

PMS Colors: Process Blue, Pantone Green, 021U Orange, Pantone Violet



HORIZONTAL
COLOR BAR AT
TRAILING EDGE

HORIZONTAL COLOR BAR

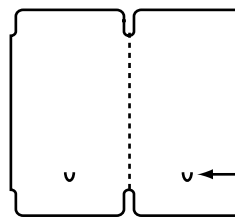

HORSESHOE
HANG HOLE

THERMAL TRANSFER TAGS
(Page5)

Thermal Transfer Circles

Part #	Color	Width	Length	Number Up	Core Size	Labels / Roll	Approx Wt / Case	Rolls / Case	Stocking Locations
--------	-------	-------	--------	-----------	-----------	---------------	------------------	--------------	--------------------

1" Circles, Floodcoated Thermal Transfer, 4" O.D., Permanent Adhesive, No Perf, Wound Out, 3" Core

10 business days	IT-1-CIR-WH	White	1" Diam. Circle	1	3	500	2	4	OH
	IT-1-CIR-RD	Red	1" Diam. Circle	1	3	500	2	4	OH
	IT-1-CIR-BLK	Black	1" Diam. Circle	1	3	500	2	4	OH
	IT-1-CIR-BL	Blue	1" Diam. Circle	1	3	500	2	4	OH
	IT-1-CIR-PU	Purple	1" Diam. Circle	1	3	500	2	4	OH
	IT-1-CIR-GR	Green	1" Diam. Circle	1	3	500	2	4	OH
	IT-1-CIR-YL	Yellow	1" Diam. Circle	1	3	500	2	4	OH
	IT-1-CIR-PK	Pink	1" Diam. Circle	1	3	500	2	4	OH
	IT-1-CIR-BR	Brown	1" Diam. Circle	1	3	500	2	4	OH
	IT-1-CIR-OR	Orange	1" Diam. Circle	1	3	500	2	4	OH

PMS Colors: 032 Red, Black, 290 Blue, 265 Purple, 345 Green, Pantone Yellow, 1905 Pink, 4705 Brown, 1495 Orange

1" Circles, Fluorescent Thermal Transfer, 4" O.D., Permanent Adhesive, Perfed Each, Wound Out, 3" Core

10 business days	FL-1-CIR-RD	Red	1" Diam. Circle	1	3	500	2	4	OH
	FL-1-CIR-CH	Chartreuse	1" Diam. Circle	1	3	500	2	4	OH
	FL-1-CIR-GR	Green	1" Diam. Circle	1	3	500	2	4	OH
	FL-1-CIR-OR	Orange	1" Diam. Circle	1	3	500	2	4	OH
	FL-1-CIR-PK	Pink	1" Diam. Circle	1	3	500	2	4	OH

PMS Colors: 805 Red, Chartreuse (Yellow-Green), 802 Green, 804 Orange, 806 Pink

1 1/2" Circles, Floodcoated Thermal Transfer, 5" O.D., Permanent Adhesive, No Perf, Wound Out, 3" Core

10 business days	IT-15-CIR-WH	White	1.5" Diam. Circle	1	3	1000	3	4	OH
	IT-15-CIR-RD	Red	1.5" Diam. Circle	1	3	1000	3	4	OH
	IT-15-CIR-BLK	Black	1.5" Diam. Circle	1	3	1000	3	4	OH
	IT-15-CIR-BL	Blue	1.5" Diam. Circle	1	3	1000	3	4	OH
	IT-15-CIR-PU	Purple	1.5" Diam. Circle	1	3	1000	3	4	OH
	IT-15-CIR-GR	Green	1.5" Diam. Circle	1	3	1000	3	4	OH
	IT-15-CIR-YL	Yellow	1.5" Diam. Circle	1	3	1000	3	4	OH
	IT-15-CIR-PK	Pink	1.5" Diam. Circle	1	3	1000	3	4	OH
	IT-15-CIR-BR	Brown	1.5" Diam. Circle	1	3	1000	3	4	OH
	IT-15-CIR-OR	Orange	1.5" Diam. Circle	1	3	1000	3	4	OH

PMS Colors: 032 Red, Black, 290 Blue, 265 Purple, 345 Green, Pantone Yellow, 1905 Pink, 4705 Brown, 1495 Orange

1 1/2" Circles, Thermal Transfer, 8" O.D., Permanent Adhesive, Perfed Each, Wound Out, 3" Core

10 business days	RT-15-CIR-WH	White	1.5" Diam. Circle	1	3	3500	14	8	OH
------------------	--------------	-------	-------------------	---	---	------	----	---	----

1 1/2" Circles, Fluorescent Thermal Transfer, 8" O.D., Permanent Adhesive, Perfed Each, Wound Out, 3" Core

10 business days	FL-15-CIR-RD	Red	1.5" Diam. Circle	1	3	3286	16	8	OH
	FL-15-CIR-CH	Chartreuse	1.5" Diam. Circle	1	3	3286	16	8	OH
	FL-15-CIR-GR	Green	1.5" Diam. Circle	1	3	3286	16	8	OH
	FL-15-CIR-OR	Orange	1.5" Diam. Circle	1	3	3286	16	8	OH
	FL-15-CIR-PK	Pink	1.5" Diam. Circle	1	3	3286	16	8	OH

PMS Colors: 805 Red, Chartreuse (Yellow-Green), 802 Green, 804 Orange, 806 Pink

RFID Enabled Thermal Transfer Labels

If ordering quantity of 101M and above, please call for pricing

Part #	Width	Length	Core Size	Labels / Roll	Rolls / Carton
--------	-------	--------	-----------	---------------	----------------

Printronix SL5000r / SL4m Alien Squiggle * EPC Class 1, Gen 2 * 96 bit * UHF * 915 MHz, Perfed, Thermal Transfer, Perm Adh

RFT-4-1-AL1.2-PRIN-3 (Higgs-3 IC)	4	1	3	2500	4
RFT-4-2-AL1.2-PRIN-3 (Higgs-3 IC)	4	2	3	2500	4
RFT-4-6-AL1.2-PRIN-3 (Higgs-3 IC)	4	6	3	800	5

Printronix SL5000r / SL4m Avery AD227 * EPC Class 1, Gen 2 * 96 bit * UHF * 915 MHz, Perfed, Thermal Transfer, Perm Adh

RFT-4-2-AV1.2-PRIN-3	4	2	3	2500	4
RFT-4-6-AV1.2-PRIN-3	4	6	3	800	5

Zebra R 110xi/R 170xi Alien Squiggle * EPC Class 1, Gen 2 * 96 bit * UHF * 915 MHz, Perfed, Thermal Transfer, Perm Adh

RFT-4-1-AL1.2-ZEB-3 (Higgs-3 IC)	4	1	3	2500	4
RFT-4-2-AL1.2-ZEB-3 (Higgs-3 IC)	4	2	3	2500	4
RFT-4-4-AL1.2-ZEB-3 (Higgs-3 IC)	4	4	3	1000	5
RFT-4-6-AL1.2-ZEB-3 (Higgs-3 IC)	4	6	3	800	5
RFT-4-6-AL1.2-ZEB-FF (Higgs-3 IC)	4	6	FF	800	4
RFT-4-6-ALH-ZEB-3 (Higgs-4 IC)	4	6	3	800	5

Zebra R 110xi/R 170xi Avery AD227 * EPC Class 1, Gen 2 * 96 bit * UHF * 915 MHz, Perfed, Thermal Transfer, Perm Adh

RFT-4-2-AV1.2-ZEB-3	4	2	3	2500	4
RFT-4-6-AV1.2-ZEB-3	4	6	3	800	5

Zebra RZ400 / RZ600 Alien / Avery * EPC Class 1, Gen 2 * 96 bit * UHF * 915 MHz, Perfed, Thermal Transfer, Perm Adh

RFT-4-2-AL2-RZ400-3 (Higgs-3 IC)	4	2	3	2500	4
RFT-4-6-AL2-RZ400-3 (Higgs-3 IC)	4	6	3	800	5
RFT-4-6-AV2-RZ400-3	4	6	3	800	5

Zebra RP4T Alien Squiggle * EPC Class 1, Gen 2 * 96 bit * UHF * 915 MHz, Perfed, Thermal Transfer, Perm Adh

RFT-4-2-AL2-ZEB-RP4T (Higgs-3 IC)	4	2	1.375	200	25
-----------------------------------	---	---	-------	-----	----

Monarch 9855 Avery AD227 * EPC Class 1, Gen 2 * 96 bit * UHF * 915 MHz, Perfed, Thermal Transfer, Perm Adh

RFT-4-2-AV2-MON9855	4	2	3	2500	4
RFT-4-6-AV2-MON9855	4	6	3	800	5

Avery 6405 Avery AD227 * EPC Class 1, Gen 2 * 96 bit * UHF * 915 MHz, Perfed, Thermal Transfer, Perm Adh

RFT-4-2-AV1.2-AV6405	4	2	3	1000	5
----------------------	---	---	---	------	---

Datamax H Class Alien Squiggle * EPC Class 1, Gen 2 * 96 bit * UHF * 915 MHz, Perfed, Thermal Transfer, Perm Adh

RFT-4-2-AL1.2-DA,H-3 (Higgs-3 IC)	4	2	3	2500	4
RFT-4-6-AL1.2-DA,H-3 (Higgs-3 IC)	4	6	3	800	5

Intermec PM4i Alien Squiggle * EPC Class 1, Gen 2 * 96 bit * UHF * 915 MHz, Perfed, Thermal Transfer, Perm Adh

RFT-4-2-AL1.2-I,PM4i (Higgs-3 IC)	4	2	3	2500	4
RFT-4-6-AL1.2-I,PM4i (Higgs-3 IC)	4	6	3	800	5

Chip-neutral insertion process, compatible with available UHF (915 MHz) or HF (13.56 MHz) transponders. Insertion in a variety of materials: TTR, films, tag, and synthetic tag. Specialty adhesives available. Pre-encoding and imprinting available, delivered 100% verified. DOD-Compliant Label Service Bureau. To receive RFID bracket pricing, quantities must be met. RFID is subject to a 40% restocking fee. RFID reworks: \$100 plus the cost of labels. All RFID shipments are required to be insured. Alien Squiggle and Avery AD227 are trademarks of their respective manufacturers.

Direct Thermal Labels

Part #	Width	Length	Number Up	Core Size	Labels / Roll	Approx Wt / Case	Rolls / Case	Stocking Locations
--------	-------	--------	-----------	-----------	---------------	------------------	--------------	--------------------

12" O.D. Topcoated Direct Thermal (Light Visible), Permanent Adhesive, No Perf, Wound Out, 3" Core

10 business days	RD-4-6-2800-NP	4	6	1	3	2800	N/A	3	OH
------------------	----------------	---	---	---	---	------	-----	---	----

8" O.D. Topcoated Direct Thermal (Light Visible), Permanent Adhesive, Perfed Each, Wound Out, 3" Core

	RD-1-1-5500-3	1	1	1	3	5500	12	8	OH
10 business days	RD-1-4-1500-3	1	4	1	3	1500	12	8	OH
	RD-15-1-5500-3	1.5	1	1	3	5500	18	8	OH, AZ
10 business days	RD-15-125-4450-3	1.5	1.25	1	3	4450	19	8	OH
	RD-15-15-3600-3	1.5	1.5	1	3	3600	17	8	OH, AZ
	RD-2-1-5500-3	2	1	1	3	5500	23	8	OH, AZ
10 business days	RD-2-1-5500-NP	2	1	1	3	5500	23	8	OH
	RD-2-15-3600-3	2	1.5	1	3	3600	23	8	OH
	RD-2-2-2900-3	2	2	1	3	2900	24	8	OH, AZ
	RD-2-3-1900-3	2	3	1	3	1900	23	8	OH
10 business days	RD-225-125-4450-3	2.25	1.25	1	3	4450	25	8	OH, AZ
	RD-225-25-2500-3	2.25	2.5	1	3	2500	29	8	OH
	RD-25-1-5500-3	2.5	1	1	3	5500	29	8	OH
10 business days	RD-25-15-3600-3	2.5	1.5	1	3	3600	N/A	8	OH
	RD-25-2-2900-3	2.5	2	1	3	2900	29	8	OH
	RD-3-1-5500-3	3	1	1	3	5500	33	8	OH, AZ
10 business days	RD-3-15-3600-3	3	1.5	1	3	3600	32	8	OH
	RD-3-2-2900-3	3	2	1	3	2900	34	8	OH, AZ
10 business days	RD-3-3-1900-3	3	3	1	3	1900	35	8	OH, AZ
	RD-3-5-1200-3	3	5	1	3	1200	35	8	OH, AZ
	RD-3125-5-1200-3	3.125	5	1	3	1200	18	4	OH
10 business days	RD-35-1-5500-3	3.5	1	1	3	5500	20	4	OH, AZ
	RD-35-15-3600-3	3.5	1.5	1	3	3600	19	4	OH, AZ
	RD-35-15-3600-NP	3.5	1.5	1	3	3600	19	4	OH
	RD-35-35-1600-3	3.5	3.5	1	3	1600	21	4	OH
	RD-4-1-5500-3	4	1	1	3	5500	23	4	OH, AZ
	RD-4-15-3600-3	4	1.5	1	3	3600	21	4	OH, AZ
	RD-4-2-2900-3	4	2	1	3	2900	23	4	OH, AZ
	RD-4-25-2500-3	4	2.5	1	3	2500	26	4	OH, AZ
	RD-4-3-1900-3	4	3	1	3	1900	22	4	OH, AZ
	RD-4-4-1500-3	4	4	1	3	1500	23	4	OH, AZ
	RD-4-6-1000-3	4	6	1	3	1000	24	4	OH, AZ
	RD-4-65-900-3	4	6.5	1	3	900	23	4	OH, AZ
	RD-4-8-750-3	4	8	1	3	750	24	4	WI
10 business days	RD-45-25-2500-3	4.5	2.5	1	3	2500	30	4	OH

Non-Topcoated Direct Thermal is an uncoated medium sensitivity product with an acrylic permanent adhesive. This material has excellent image quality. Because this material is uncoated, it should be tested by the end user before ordering large quantities. This product should not be used in applications that require extreme environmental resistance. Application Temp (+32° F), Service Temp (-4° to +176° F).

Topcoated Direct Thermal is a topcoated medium sensitivity product with an acrylic permanent adhesive. This material has excellent image quality and it provides excellent results in most environmental conditions. We recommend that any direct thermal material be tested in an end-user application before ordering large quantities. Application Temp (+32° F), Service Temp (-4° to +176° F).

Part #	Width	Length	Number Up	Core Size	Labels / Roll	Approx Wt / Case	Rolls / Case	Stocking Locations
--------	-------	--------	-----------	-----------	---------------	------------------	--------------	--------------------

8" O.D. Topcoated Direct Thermal (Light Visible), Permanent Adhesive, Perfed Each, Wound Out, 3" Core (continued)

RD-45-45-1400-3	4.5	4.5	1	3	1400	27	4	OH
RD-45-6-1000-3	4.5	6	1	3	1000	26	4	OH
RD-6-4-1500-3	6	4	1	3	1500	35	4	OH
RD-6-6-1000-3	6	6	1	3	1000	38	4	OH
RD-4-500-1-3*	4	500'	1	3	1	24	4	OH

10 business days

* This item's price is per roll. Continuous roll of material that is 4 inches wide by 500 feet long. Liner is slit down middle for easy removal.

8" O.D. Non-Topcoated Direct Thermal (Light Visible), Permanent Adhesive, Perfed Each, Wound Out, 3" Core

RDS-2-1-5500-3	2	1	1	3	5500	23	8	OH
RDS-2-1-11000-3	2	1	2	3	11,000	23	4	OH
RDS-3-1-5500-3	3	1	1	3	5500	33	8	OH
RDS-35-1-5500-3	3.5	1	1	3	5500	20	4	OH
RDS-4-1-5500-3	4	1	1	3	5500	23	4	OH
RDS-4-2-2900-3	4	2	1	3	2900	23	4	OH
RDS-4-3-1900-3	4	3	1	3	1900	22	4	OH
RDS-4-4-1500-3	4	4	1	3	1500	23	4	OH
RDS-4-6-1000-3	4	6	1	3	1000	24	4	OH, WI
RDS-4-6-1000-NP	4	6	1	3	1000	24	4	OH
RDS-4-65-900-3	4	6.5	1	3	900	23	4	OH
RDS-4-8-750-3	4	8	1	3	750	24	4	WI

10 business days

8" O.D. Removable Adhesive, Topcoated Direct Thermal (Light Visible), Perfed Each, Wound Out, 3" Core

RDE-15-1-5500-3	1.5	1	1	3	5500	18	8	OH
RDE-2-1-5500-3	2	1	1	3	5500	33	8	OH
RDE-3-1-5500-3	3	1	1	3	5500	33	8	OH
RDE-3-5-1200-3	3	5	1	3	1200	35	8	OH
RDE-35-15-3600-3	3.5	1.5	1	3	3600	19	4	OH
RDE-4-1-5500-3	4	1	1	3	5500	23	4	OH
RDE-4-2-2900-3	4	2	1	3	2900	23	4	OH
RDE-4-3-1900-3	4	3	1	3	1900	22	4	OH
RDE-4-4-1500-3	4	4	1	3	1500	23	4	OH
RDE-4-6-1000-3	4	6	1	3	1000	24	4	OH, AZ

10 business days

6" O.D. Topcoated Direct Thermal (Light Visible), Permanent Adhesive, Perfed Each, Wound Out, 3" Core

RD-2-1-2750-3	2	1	1	3	2750	20	12	OH
RD-3-2-1475-3	3	2	1	3	1475	22	8	OH
RD-4-6-525-3	4	6	1	3	525	28	8	OH

10 business days

5" O.D. Topcoated Direct Thermal (Light Visible), Permanent Adhesive, Perfed Each, Wound Out, 1" Core

RD-2-1-2500-1	2	1	1	1	2500	18	12	OH
RD-225-125-2100-1	2.25	1.25	1	1	2100	21	12	OH
RD-25-1-2500-1	2.5	1	1	1	2500	22	12	OH
RD-3-1-2500-1	3	1	1	1	2500	25	12	OH, AZ
RD-3-3-890-1	3	3	1	1	890	26	12	OH
RD-35-1-2500-1	3.5	1	1	1	2500	29	12	OH
RD-4-1-2500-1	4	1	1	1	2500	32	12	OH

10 business days

10 business days

Shaded items have a lead time of ten business days.

Part #	Width	Length	Number Up	Core Size	Labels / Roll	Approx Wt / Case	Rolls / Case	Stocking Locations
--------	-------	--------	-----------	-----------	---------------	------------------	--------------	--------------------

5" O.D. Topcoated Direct Thermal (Light Visible), Permanent Adhesive, Perfed Each, Wound Out, 1" Core (continued)

10 business days	RD-4-15-1800-1	4	1.5	1	1	1800	32	12	OH
	RD-4-2-1320-1	4	2	1	1	1320	34	12	OH
10 business days	RD-4-3-890-1	4	3	1	1	890	23	12	OH
	RD-4-4-700-1	4	4	1	1	700	35	12	OH
10 business days	RD-4-6-460-1	4	6	1	1	460	35	12	OH, AZ
	RD-4-65-380-1	4	6.5	1	1	380	31	12	OH

4" O.D. Topcoated Direct Thermal (Light Visible), Permanent Adhesive, Perfed Each, Wound Out, 1" Core

10 business days	RD-1-05-4900-1	1	0.5	2	1	4900	9	12	OH
	RD-1-1-2750-1	1	1	2	1	2750	9	12	OH
	RD-1-3-500-1	1	3	1	1	500	6	12	OH
	RD-125-085-1800-1	1.25	0.85	1	1	1800	N/A	12	OH
	RD-125-1-1375-1	1.25	1	1	1	1375	6	12	OH
	RD-15-075-3500-1	1.5	0.75	2	1	3500	14	12	OH
	RD-15-1-1375-1	1.5	1	1	1	1375	7	12	OH
	RD-15-1-2750-1	1.5	1	2	1	2750	15	12	OH
	RD-15-15-960-1	1.5	1.5	1	1	960	7	12	OH
10 business days	RD-2-1-1375-1	2	1	1	1	1375	9	12	OH, AZ
	RD-2-1-2750-1	2	1	2	1	2750	18	12	OH
	RD-2-15-960-1	2	1.5	1	1	960	10	12	OH
	RD-2-2-735-1	2	2	1	1	735	10	12	OH
	RD-2-4-380-1	2	4	1	1	380	10	12	OH
	RD-225-1-1375-1	2.25	1	1	1	1375	11	12	OH
10 business days	RD-225-125-1135-1	2.25	1.25	1	1	1135	10	12	OH, AZ
	RD-225-2-735-1	2.25	2	1	1	735	11	12	OH
	RD-225-3-500-1	2.25	3	1	1	500	11	12	OH
	RD-225-4-440-1	2.25	4	1	1	440	N/A	12	OH
	RD-25-075-1750-1	2.5	0.75	1	1	1750	N/A	12	OH
	RD-25-1-1375-1	2.5	1	1	1	1375	12	12	OH
10 business days	RD-25-15-960-1	2.5	1.5	1	1	960	12	12	OH
	RD-3-075-1750-1	3	0.75	1	1	1750	14	12	OH
	RD-3-1-1375-1	3	1	1	1	1375	14	12	AZ, WI
	RD-3-15-960-1	3	1.5	1	1	960	10	12	OH
	RD-3-2-735-1	3	2	1	1	735	15	12	OH
	RD-3-3-500-1	3	3	1	1	500	13	12	OH
10 business days	RD-3-5-300-1	3	5	1	1	300	14	12	OH
	RD-35-1-1375-1	3.5	1	1	1	1375	16	12	OH, AZ
	RD-35-15-960-1	3.5	1.5	1	1	960	14	12	OH
	RD-35-5-300-1	3.5	5	1	1	300	N/A	12	OH
10 business days	RD-4-05-2450-1	4	0.5	1	1	2450	17	12	OH
	RD-4-1-1375-1	4	1	1	1	1375	17	12	OH, AZ
	RD-4-15-960-1	4	1.5	1	1	960	17	12	OH, AZ
	RD-4-2-735-1	4	2	1	1	735	18	12	AZ, WI
10 business days	RD-4-25-595-1	4	2.5	1	1	595	19	12	OH
	RD-4-3-500-1	4	3	1	1	500	18	12	OH, AZ
10 business days	RD-4-4-380-1	4	4	1	1	380	18	12	OH

Part #	Width	Length	Number Up	Core Size	Labels / Roll	Approx Wt / Case	Rolls / Case	Stocking Locations
4" O.D. Topcoated Direct Thermal (Light Visible), Permanent Adhesive, Perf Each, Wound Out, 1" Core <i>(continued)</i>								
RD-4-5-350-1	4	5	1	1	350	17	12	OH
RD-4-6-250-1	4	6	1	1	250	17	12	AZ, WI
RD-4-65-230-1	4	6.5	1	1	230	17	12	OH
RD-4-8-200-1	4	8	1	1	200	20	12	OH
RD-4-200-1-1*	4	200'	1	1	1	28	12	OH

10 business days

10 business days

*Continuous roll of material that is 4 inches wide by 200 feet long. Liner is slit down middle for easy removal.

4" O.D. Removable Adhesive, Topcoated Direct Thermal (Light Visible), Perf Each, Wound Out, 1" Core

RDE-2-1-1375-1	2	1	1	1	1375	10	12	OH
RDE-225-125-1135-1	2.25	1.25	1	1	1135	11	12	OH
RDE-3-1-1375-1	3	1	1	1	1375	14	12	OH
RDE-4-1-1375-1	4	1	1	1	1375	19	12	OH
RDE-4-15-960-1	4	1.5	1	1	960	19	12	OH
RDE-4-2-735-1	4	2	1	1	735	19	12	OH
RDE-4-6-250-1	4	6	1	1	250	20	12	OH

10 business days

2.5" O.D. Topcoated Direct Thermal (Light Visible), Perm Adhes, Perf Each, Wound Out, .75" Core Sensemark on Liner

RD-2-125-460-075	2	1.25	1	0.75	460	11	36	OH
RD-3-1-560-075	3	1	1	0.75	560	16	36	OH
RD-3-2-300-075	3	2	1	0.75	300	18	36	OH
RD-4-2-300-075	4	2	1	0.75	300	24	36	OH
RD-4-3-200-075	4	3	1	0.75	200	24	36	OH
RD-4-4-160-075	4	4	1	0.75	160	19	36	OH
RD-4-6-105-075	4	6	1	0.75	105	25	36	OH
RD-4-65-90-075	4	6.5	1	0.75	90	N/A	36	OH

10 business days

10 business days

10 business days

For Zebra Printers: QL, QL Plus Series. For Datamax Printers: RL4, RL3.

Direct Thermal Shipping System Labels

Part #	O.D.	Width	Length	Number Up	Core Size	Labels / Roll	Approx Wt / Case	Rolls / Case	Stocking Locations
--------	------	-------	--------	-----------	-----------	---------------	------------------	--------------	--------------------

FedEx Direct Thermal Shipping Labels with 3/4" DOC Tab (Near IR), Permanent Adhesive

RPS-4-675-250-1	3.75"	4	6.75	1	1	250	22	12	OH
RPS-4-675-250-1-NP	3.75"	4	6.75	1	1	250	22	12	OH
RPS-4-675-250-15-NP	3.75"	4	6.75	1	1.5	250	22	12	OH
RPS-4-675-820-3	7.25"	4	6.75	1	3	820	24	4	OH
RPS-4-675-820-3-NP	7.25"	4	6.75	1	3	820	24	4	OH

10 business days

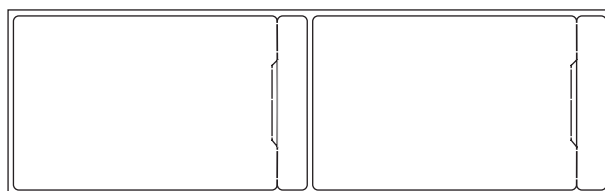

FEDEX SHIPPING LABELS
3/4" DOC TAB

Shaded items have a lead time of ten business days.

Part #	O.D.	Width	Length	Number Up	Core Size	Labels / Roll	Approx Wt / Case	Rolls / Case	Stocking Locations
--------	------	-------	--------	-----------	-----------	---------------	------------------	--------------	--------------------

UPS Direct Thermal Shipping Labels with 2" DOC Tab (Near IR), Permanent Adhesive, Perfed each

10 business days	RPS-4-825-200-1	3.75"	4	8.25	1	1	200	N/A	12	OH
	RPS-4-825-750-3	8"	4	8.25	1	3	750	N/A	4	OH

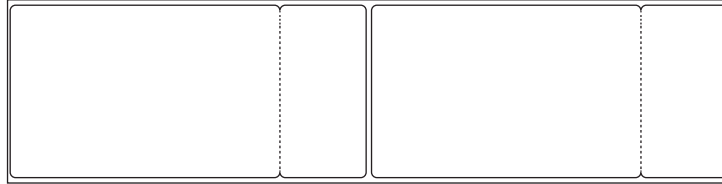

UPS SHIPPING LABELS
2" DOC TAB

Direct Thermal Fanfold Labels & Tags

Part #	Width	Length	Labels / Fold	FF= Fanfold	Labels / Stack	Approx Wt / Case	Labels / Case	Stocking Locations
--------	-------	--------	---------------	-------------	----------------	------------------	---------------	--------------------

Fanfold Stack, Topcoated Direct Thermal (Light Visible), Permanent Adhesive, Perfed Each

10 business days	RD-3-2-7500-FF	3	2	5	FF	7500	N/A	15000	OH
	RD-4-3-8000-FF	4	3	4	FF	8000	N/A	8000	OH
	RD-4-6-2000-FF	4	6	2	FF	2000	22	4000	OH, AZ
10 business days	RD-4-65-2000-FF	4	6.5	2	FF	2000	24	4000	OH
	RD-4-8-1000-FF	4	8	1	FF	1000	N/A	2000	OH

Fanfold Stack, Non-Topcoated Direct Thermal (Light Visible), Permanent Adhesive, Perfed Each

10 business days	RDS-4-6-2000-FF	4	6	2	FF	2000	22	4000	OH, AZ
	RDS-4-65-2000-FF	4	6.5	2	FF	2000	24	4000	OH

7 pt. Direct Thermal Tag Stock, Postal Bag and Tray Tag, Fanfold

REP-334-1915-NF	3.34	1.915	1	FF	3200	50	32000	OH
-----------------	------	-------	---	----	------	----	-------	----

Postal tags are manufactured to run through a Microcom 410 thermal printer.

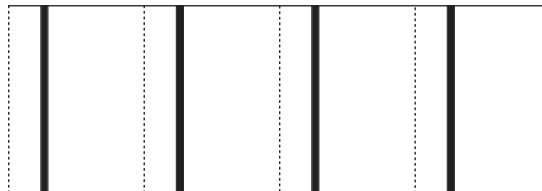

DIRECT THERMAL
POSTAL BAG AND TRAY TAGS

Dymo Compatible Direct Thermal Labels

Part #	Width	Length	Number Up	Labels / Roll	Approx Wt / Case	Rolls / Case	Stocking Locations
Topcoated Direct Thermal (Light Visible), Permanent Adhesive, No Perf, Wound Out, 1" Core							
DYM-05-1-1000-1	0.5	1	2	1000	N/A	10	WI
DYM-5625-34375-260-1	0.5625	3.4375	2	260	N/A	10	WI
DYM-075-2-500-1	0.75	2	1	500	N/A	10	WI
DYM-1-1-750-1	1	1	1	750	N/A	10	WI
DYM-1-2125-500-1	1	2.125	1	500	N/A	10	WI
DYM-109375-35-350-1	1.09375	3.5	1	350	N/A	10	WI
DYM-109375-35-350-YL	1.09375	3.5	1	350	N/A	10	WI
DYM-11-35-700-1	1.1	3.5	2	700	N/A	10	WI
DYM-140625-35-350-1	1.40625	3.5	1	350	N/A	10	WI
DYM-164-1235-200-1	1.64	1.235	1	200	N/A	10	WI
DYM-2125-275-320-1	2.125	2.75	1	320	N/A	10	WI
DYM-2125-396875-220-1	2.125	3.96875	1	220	N/A	10	WI
DYM-225-125-1000-1	2.25	1.25	1	1000	N/A	10	WI
DYM-23125-4-300-1	2.3125	4	1	300	N/A	10	WI
DYM-41-625-200-1*	4.1	6.25	1	200	N/A	10	WI

10 business days

*Only compatible with LabelWriter 4XL

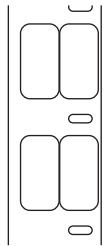

DYM-05-1-1000-1
EXTRA SMALL
MULTIPURPOSE



DYM-5625-34375-260-1
FILE FOLDER
LABEL

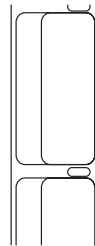

DYM-075-2-500-1
RETURN
ADDRESS LABEL

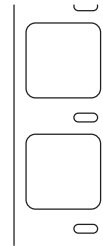

DYM-1-1-750-1
SQUARE
MULTIPURPOSE

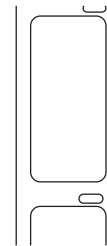

DYM-1-2125-500-1
SMALL
MULTIPURPOSE

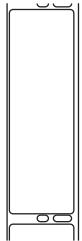

DYM-109375-35-350-1
ADDRESS
LABEL

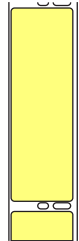

DYM-109375-35-350-YL
YELLOW
ADDRESS LABEL



DYM-11-35-700-1
2-UP ADDRESS
LABEL



DYM-140625-35-350-1
LARGE ADDRESS
LABEL

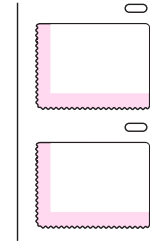

DYM-164-1235-200-1
STAMP WITH
PINK EDGE

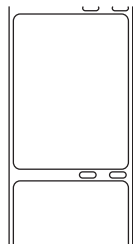

DYM-2125-275-320-1
LARGE
MULTIPURPOSE

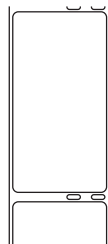

DYM-2125-396875-220-1
SHIPPING
LABEL

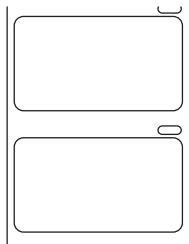

DYM-225-125-1000-1
MEDIUM
MULTIPURPOSE

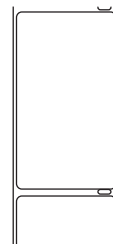

DYM-23125-4-300-1
LARGE
SHIPPING LABEL

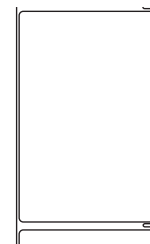

DYM-41-625-200-1
OVERSIZED
SHIPPING LABEL

Shaded items have a lead time of ten business days.

Floodcoated Direct Thermal Labels

Part #	Color	Width	Length	Number Up	Core Size	Labels / Roll	Approx Wt / Case	Rolls / Case	Stocking Locations
--------	-------	-------	--------	-----------	-----------	---------------	------------------	--------------	--------------------

8" O.D. Floodcoated Topcoated Direct Thermal (Light Visible), Permanent Adhesive, Perfed Each, Wound Out, 3" Core

RD-3-1-5500-YL	Yellow	3	1	1	3	5500	34	8	OH
RD-3-1-5500-RD	Red	3	1	1	3	5500	34	8	OH
RD-3-1-5500-BL	Blue	3	1	1	3	5500	34	8	OH
RD-3-1-5500-GR	Green	3	1	1	3	5500	34	8	OH
RD-3-1-5500-OR	Orange	3	1	1	3	5500	34	8	OH
RD-3-5-1200-YL	Yellow	3	5	1	3	1200	36	8	OH
RD-3-5-1200-RD	Red	3	5	1	3	1200	36	8	OH
RD-3-5-1200-BL	Blue	3	5	1	3	1200	36	8	OH
RD-3-5-1200-GR	Green	3	5	1	3	1200	36	8	OH
RD-3-5-1200-OR	Orange	3	5	1	3	1200	36	8	OH
RD-4-2-2900-YL	Yellow	4	2	1	3	2900	23	4	OH
RD-4-2-2900-RD	Red	4	2	1	3	2900	23	4	OH
RD-4-2-2900-BL	Blue	4	2	1	3	2900	23	4	OH
RD-4-2-2900-GR	Green	4	2	1	3	2900	23	4	OH
RD-4-2-2900-OR	Orange	4	2	1	3	2900	23	4	OH
RD-4-3-1900-YL	Yellow	4	3	1	3	1900	23	4	OH
RD-4-3-1900-RD	Red	4	3	1	3	1900	23	4	OH
RD-4-3-1900-BL	Blue	4	3	1	3	1900	23	4	OH
RD-4-3-1900-GR	Green	4	3	1	3	1900	23	4	OH
RD-4-3-1900-OR	Orange	4	3	1	3	1900	23	4	OH
RD-4-6-1000-YL	Yellow	4	6	1	3	1000	24	4	OH
RD-4-6-1000-RD	Red	4	6	1	3	1000	24	4	OH
RD-4-6-1000-BL	Blue	4	6	1	3	1000	24	4	OH
RD-4-6-1000-GR	Green	4	6	1	3	1000	24	4	OH
RD-4-6-1000-OR	Orange	4	6	1	3	1000	24	4	OH

10 business days

4" O.D. Floodcoated Topcoated Direct Thermal (Light Visible), Permanent Adhesive, Perfed Each, Wound Out, 1" Core

RD-15-1-1375-YL	Yellow	1.5	1	1	1	1375	7	12	OH
RD-15-1-1375-RD	Orange	1.5	1	1	1	1375	7	12	OH
RD-15-1-1375-BL	Blue	1.5	1	1	1	1375	7	12	OH
RD-15-1-1375-GR	Green	1.5	1	1	1	1375	7	12	OH
RD-15-1-1375-OR	Orange	1.5	1	1	1	1375	7	12	OH
RD-2-1-1375-YL	Yellow	2	1	1	1	1375	9	12	OH
RD-2-1-1375-RD	Red	2	1	1	1	1375	9	12	OH
RD-2-1-1375-BL	Blue	2	1	1	1	1375	9	12	OH
RD-2-1-1375-GR	Green	2	1	1	1	1375	9	12	OH
RD-2-1-1375-OR	Orange	2	1	1	1	1375	9	12	OH
RD-225-125-1135-YL	Yellow	2.25	1.25	1	1	1135	10	12	OH
RD-225-125-1135-RD	Orange	2.25	1.25	1	1	1135	10	12	OH
RD-225-125-1135-BL	Blue	2.25	1.25	1	1	1135	10	12	OH
RD-225-125-1135-GR	Green	2.25	1.25	1	1	1135	10	12	OH
RD-225-125-1135-OR	Orange	2.25	1.25	1	1	1135	10	12	OH
RD-2-3-500-YL	Yellow	2	3	1	1	500	10	12	OH
RD-2-3-500-RD	Red	2	3	1	1	500	10	12	OH
RD-2-3-500-BL	Blue	2	3	1	1	500	10	12	OH

10 business days

Part #	Color	Width	Length	Nbr Up	Core Size	Labels / Roll	Approx Wt / Case	Rolls / Case	Stocking Locations
--------	-------	-------	--------	--------	-----------	---------------	------------------	--------------	--------------------

4" O.D. Floodcoated Topcoated Direct Thermal (Light Visible), Perm Adhes, Perf Each, Wound Out, 1" Core (continued)

RD-2-3-500-GR	Green	2	3	1	1	500	10	12	OH
RD-2-3-500-OR	Orange	2	3	1	1	500	10	12	OH
RD-3-1-1375-YL	Yellow	3	1	1	1	1375	14	12	OH
RD-3-1-1375-RD	Orange	3	1	1	1	1375	14	12	OH
RD-3-1-1375-BL	Blue	3	1	1	1	1375	14	12	OH
RD-3-1-1375-GR	Green	3	1	1	1	1375	14	12	OH
RD-3-1-1375-OR	Orange	3	1	1	1	1375	14	12	OH
RD-3-2-735-YL	Yellow	3	2	1	1	735	14	12	OH
RD-3-2-735-RD	Red	3	2	1	1	735	14	12	OH
RD-3-2-735-BL	Blue	3	2	1	1	735	14	12	OH
RD-3-2-735-GR	Green	3	2	1	1	735	14	12	OH
RD-3-2-735-OR	Orange	3	2	1	1	735	14	12	OH
RD-3-5-300-YL	Yellow	3	5	1	1	300	N/A	12	OH
RD-3-5-300-RD	Red	3	5	1	1	300	N/A	12	OH
RD-3-5-300-BL	Blue	3	5	1	1	300	N/A	12	OH
RD-3-5-300-GR	Green	3	5	1	1	300	N/A	12	OH
RD-3-5-300-OR	Orange	3	5	1	1	300	N/A	12	OH
RD-4-1-1375-YL	Yellow	4	1	1	1	1375	17	12	OH
RD-4-1-1375-RD	Red	4	1	1	1	1375	17	12	OH
RD-4-1-1375-BL	Blue	4	1	1	1	1375	17	12	OH
RD-4-1-1375-GR	Green	4	1	1	1	1375	17	12	OH
RD-4-1-1375-OR	Orange	4	1	1	1	1375	17	12	OH
RD-4-2-735-YL	Yellow	4	2	1	1	735	18	12	OH
RD-4-2-735-RD	Red	4	2	1	1	735	18	12	OH
RD-4-2-735-BL	Blue	4	2	1	1	735	18	12	OH
RD-4-2-735-GR	Green	4	2	1	1	735	18	12	OH
RD-4-2-735-OR	Orange	4	2	1	1	735	18	12	OH
RD-4-3-500-YL	Yellow	4	3	1	1	500	18	12	OH
RD-4-3-500-RD	Red	4	3	1	1	500	18	12	OH
RD-4-3-500-BL	Blue	4	3	1	1	500	18	12	OH
RD-4-3-500-GR	Green	4	3	1	1	500	18	12	OH
RD-4-3-500-OR	Orange	4	3	1	1	500	18	12	OH
RD-4-4-380-YL	Yellow	4	4	1	1	380	18	12	OH
RD-4-4-380-RD	Red	4	4	1	1	380	18	12	OH
RD-4-4-380-BL	Blue	4	4	1	1	380	18	12	OH
RD-4-4-380-GR	Green	4	4	1	1	380	18	12	OH
RD-4-4-380-OR	Orange	4	4	1	1	380	18	12	OH
RD-4-6-250-YL	Yellow	4	6	1	1	250	17	12	OH
RD-4-6-250-RD	Red	4	6	1	1	250	17	12	OH
RD-4-6-250-BL	Blue	4	6	1	1	250	17	12	OH
RD-4-6-250-GR	Green	4	6	1	1	250	17	12	OH
RD-4-6-250-OR	Orange	4	6	1	1	250	17	12	OH
RD-4-65-230-YL	Yellow	4	6.5	1	1	230	17	12	OH
RD-4-65-230-RD	Red	4	6.5	1	1	230	17	12	OH
RD-4-65-230-BL	Blue	4	6.5	1	1	230	17	12	OH
RD-4-65-230-GR	Green	4	6.5	1	1	230	17	12	OH
RD-4-65-230-OR	Orange	4	6.5	1	1	230	17	12	OH

10 business days

PMS Colors: 80% Pantone Yellow, 80% 032 Red, 80% 292 Blue, 80% 345 Green, 80% 1505 Orange

Liner-free Repositionable Direct Thermal Rolls

Part #	Color	Width Inches	Length Feet	O.D.	Core Size	Gauge / gsm	Approx Wt / Case	Rolls / Case	Stocking Locations
--------	-------	--------------	-------------	------	-----------	-------------	------------------	--------------	--------------------

2 Go, Center Repositionable Adhesive, 55gsm, 15# Base Direct Thermal Roll

MS2141602GO	White	2.25	160'	2.75"	1"	55	11	24	PA
MS3181602GO	White	3.125	160'	2.75"	1"	55	14	24	PA

2Go, Side Edge Repositionable Adhesive, 55gsm, 15# Base Direct Thermal Roll

MS214782GOSE	White	2.25	78'	1.875"	.5"	55	17	72	PA
MS3181602GOSE	White	3.125	160'	2.75"	1"	55	14	24	PA
MS3181602GOSE-B	Blue	3.125	160'	2.75"	1"	55	14	24	PA
MS3181602GOSE-P	Pink	3.125	160'	2.75"	1"	55	14	24	PA
MS3181602GOSE-C	Canary	3.125	160'	2.75"	1"	55	14	24	PA
MS3181602GOSE-G	Green	3.125	160'	2.75"	1"	55	14	24	PA
MS3181602GOSE-O	Orange	3.125	160'	2.75"	1"	55	14	24	PA
MS3181602GOSE-V	Violet	3.125	160'	2.75"	1"	55	14	24	PA

PMS Colors: 306 Blue, 213 Pink, 100 Canary, 2283 Green, 150 Orange, 515 Violet

3 Stripe Repositionable Adhesive 55gsm, 15# Base Direct Thermal Roll

MS2142402GO3S	White	2.25	240'	3.25"	1"	55	19	32	PA
---------------	-------	------	------	-------	----	----	----	----	----

4 Stripe Repositionable Adhesive 55gsm, 15# Base Direct Thermal Roll

MS3182402GO4S	White	3.125	240'	3.25"	1"	55	26	32	PA
---------------	-------	-------	------	-------	----	----	----	----	----

Plus, Diamond Pattern Repositionable Adhesive, 80gsm, 20# Base Direct Thermal Roll

MS214170PLUSD	White	2.25	170'	3.25"	1"	80	19	32	PA
MS318170PLUSD	White	3.125	170'	3.25"	1"	80	26	32	PA

X2, Full Coverage Repositionable Adhesive, 80gsm, 20# Base Direct Thermal Roll

MS21460X2	White	2.25	60'	1.875"	.5"	80	17	72	PA
MS214170X2	White	2.25	170'	3.25"	1"	80	19	32	PA
MS318170X2	White	3.125	170'	3.25"	1"	80	26	32	PA

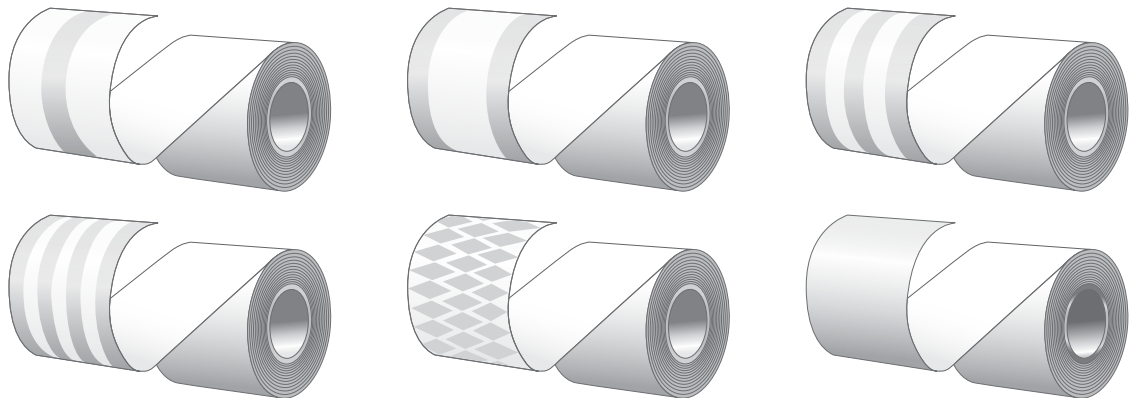

LINER-FREE REPOSITIONABLE DIRECT THERMAL ROLLS

Inkjet Labels for Epson Color Works Printers

Part #	Color	Width	Length	Number Up	Core Size	Labels / Roll	Approx Wt / Case	Rolls / Case	Stocking Locations
--------	-------	-------	--------	-----------	-----------	---------------	------------------	--------------	--------------------

8" O.D., 4.5 Mil Premium Matte Paper, Die Cut Rolls for Epson C7500, No Perf, Wound Out, 3" Core

RIJM-15-1-4700-3	White	1.5	1	1	3	4700	N/A	4	WI
RIJM-3-1-4700-3	White	3	1	1	3	4700	N/A	4	WI
RIJM-3-2-2530-3	White	3	2	1	3	2530	N/A	4	WI
RIJM-3-3-1720-3	White	3	3	1	3	1720	N/A	4	WI
RIJM-3-5-1050-3	White	3	5	1	3	1050	N/A	4	WI
RIJM-4-1-4700-3	White	4	1	1	3	4700	N/A	4	WI
RIJM-4-2-2530-3	White	4	2	1	3	2530	N/A	4	WI
RIJM-4-3-1720-3	White	4	3	1	3	1720	N/A	4	WI
RIJM-4-6-875-3	White	4	6	1	3	875	N/A	4	WI

10 business days

8" O.D., 4 Mil High Gloss Paper, Die Cut Rolls for Epson C7500, No Perf, Wound Out, 3" Core

RIJG-15-1-5300-3	White	1.5	1	1	3	5300	N/A	4	WI
RIJG-3-1-5300-3	White	3	1	1	3	5300	N/A	4	WI
RIJG-3-2-2825-3	White	3	2	1	3	2825	N/A	4	WI
RIJG-3-3-1920-3	White	3	3	1	3	1920	N/A	4	WI
RIJG-3-5-1170-3	White	3	5	1	3	1170	N/A	4	WI
RIJG-4-1-5300-3	White	4	1	1	3	5300	N/A	4	WI
RIJG-4-2-2825-3	White	4	2	1	3	2825	N/A	4	WI
RIJG-4-3-1920-3	White	4	3	1	3	1920	N/A	4	WI
RIJG-4-6-975-3	White	4	6	1	3	975	N/A	4	WI

10 business days

8" O.D., 5 Mil Kimdura - GHS/BS5609 Certified, Die Cut Rolls for Epson C7500, No Perf, Wound Out, 3" Core

RIJK-15-1-4270-3	White	1.5	1	1	3	4270	N/A	4	WI
RIJK-3-1-4270-3	White	3	1	1	3	4270	N/A	4	WI
RIJK-3-2-2265-3	White	3	2	1	3	2265	N/A	4	WI
RIJK-3-3-1540-3	White	3	3	1	3	1540	N/A	4	WI
RIJK-3-5-940-3	White	3	5	1	3	940	N/A	4	WI
RIJK-4-1-4270-3	White	4	1	1	3	4270	N/A	4	WI
RIJK-4-2-2265-3	White	4	2	1	3	2265	N/A	4	WI
RIJK-4-3-1540-3	White	4	3	1	3	1540	N/A	4	WI
RIJK-4-6-785-3	White	4	6	1	3	785	N/A	4	WI

10 business days

4" O.D., 4.5 Mil Premium Matte Paper, Die Cut Rolls for Epson C3500, Perfed Each, Wound Out, 2" Core

RIJM-3-1-960-2	White	3	1	1	2	960	N/A	8	WI
RIJM-3-2-510-2	White	3	2	1	2	510	N/A	8	WI
RIJM-3-5-215-2	White	3	5	1	2	215	N/A	8	WI
RIJM-4-1-960-2	White	4	1	1	2	960	N/A	8	WI
RIJM-4-2-510-2	White	4	2	1	2	510	N/A	8	WI
RIJM-4-3-350-2	White	4	3	1	2	350	N/A	8	WI
RIJM-4-6-180-2	White	4	6	1	2	180	N/A	8	WI

10 business days

4" O.D., 4.5 Mil Premium Matte Paper, Continuous Rolls for Epson C3500, No Perf, Wound Out, 2" Core

RIJM-2-90-1-2*	White	2	90'	1	2	1	N/A	8	WI
RIJM-3-90-1-2*	White	3	90'	1	2	1	N/A	8	WI
RIJM-4-90-1-2*	White	4	90'	1	2	1	N/A	8	WI

10 business days

* These items are priced per roll. They are continuous rolls that are 90 feet long with 1/16 inch carrier on each side for easy removal.

Shaded items have a lead time of ten business days.

Part #	Color	Width	Length	Number Up	Core Size	Labels / Roll	Approx Wt /Case	Rolls / Case	Stocking Locations
--------	-------	-------	--------	-----------	-----------	---------------	-----------------	--------------	--------------------

4" O.D., 4 Mil High Gloss Paper, Die Cut Rolls for Epson C3500, Perfed Each, Wound Out, 2" Core

10 business days	RIJG-3-1-1070-2	White	3	1	1	2	1070	N/A	8	WI
	RIJG-3-2-575-2	White	3	2	1	2	575	N/A	8	WI
	RIJG-3-5-240-2	White	3	5	1	2	240	N/A	8	WI
	RIJG-4-1-1070-2	White	4	1	1	2	1070	N/A	8	WI
	RIJG-4-2-575-2	White	4	2	1	2	575	N/A	8	WI
	RIJG-4-3-390-2	White	4	3	1	2	390	N/A	8	WI
	RIJG-4-6-200-2	White	4	6	1	2	200	N/A	8	WI

4" O.D., 4 Mil High Gloss Paper, Continuous Rolls for Epson C3500, No Perf, Wound Out, 2" Core

10 business days	RIJG-2-100-1-2*	White	2	100'	1	2	1	N/A	8	WI
	RIJG-3-100-1-2*	White	3	100'	1	2	1	N/A	8	WI
	RIJG-4-100-1-2*	White	4	100'	1	2	1	N/A	8	WI

* These items are priced per roll. They are continuous rolls that are 100 feet long with 1/16 inch carrier on each side for easy removal.

4" O.D., 5 Mil Kimdura - GHS/BS5609 Certified, Die Cut Rolls for Epson C3500, Perfed Each, Wound Out, 2" Core

10 business days	RIJK-3-1-960-2	White	3	1	1	2	960	N/A	8	WI
	RIJK-3-2-450-2	White	3	2	1	2	450	N/A	8	WI
	RIJK-3-5-185-2	White	3	5	1	2	185	N/A	8	WI
	RIJK-4-1-960-2	White	4	1	1	2	960	N/A	8	WI
	RIJK-4-2-450-2	White	4	2	1	2	450	N/A	8	WI
	RIJK-4-3-300-2	White	4	3	1	2	300	N/A	8	WI
	RIJK-4-6-150-2	White	4	6	1	2	150	N/A	8	WI

4" O.D., 3.5 Mil Matte Synthetic - GHS/BS5609 Certified, Continuous Rolls for C3500, No Perf, Wound Out, 2" Core

10 business days	RIJS-2-100-1-2*	White	2	100'	1	2	1	N/A	8	WI
	RIJS-3-100-1-2*	White	3	100'	1	2	1	N/A	8	WI
	RIJS-4-100-1-2*	White	4	100'	1	2	1	N/A	8	WI

* These items are priced per roll. They are continuous rolls that are 100 feet long with 1/16 inch carrier on each side for easy removal.

Inkjet Fanfold Stacks for Epson C3500

Part #	Color	Width	Length	Labels / Fold	FF= fanfold	Labels / Stack	Approx Wt / Case	Stacks / Case	Stocking Locations
--------	-------	-------	--------	---------------	-------------	----------------	------------------	---------------	--------------------

Fanfold Stacks, 4.5 Mil Premium Matte Paper, Fanfold Stacks for Epson C3500, Perfed Each

10 business days	RIJM-4-1-5000-FF	White	4	1	5	FF	5000	N/A	1	WI
	RIJM-4-2-4000-FF	White	4	2	4	FF	4000	N/A	1	WI
	RIJM-4-3-3000-FF	White	4	3	3	FF	3000	N/A	1	WI
	RIJM-4-6-2000-FF	White	4	6	2	FF	2000	N/A	1	WI

Fanfold Stacks, 4 Mil High Gloss Paper, Fanfold Stacks for Epson C3500, Perfed Each

10 business days	RIJG-4-1-5000-FF	White	4	1	5	FF	5000	N/A	1	WI
	RIJG-4-2-4000-FF	White	4	2	4	FF	4000	N/A	1	WI
	RIJG-4-3-3000-FF	White	4	3	3	FF	3000	N/A	1	WI
	RIJG-4-6-2000-FF	White	4	6	2	FF	2000	N/A	1	WI

Fanfold Stacks, 5 Mil Kimdura - GHS/BS5609 Certified, Fanfold Stacks for Epson C3500, Perfed Each

10 business days	RIJK-4-1-5000-FF	White	4	1	5	FF	5000	N/A	1	WI
	RIJK-4-2-4000-FF	White	4	2	4	FF	4000	N/A	1	WI
	RIJK-4-3-3000-FF	White	4	3	3	FF	3000	N/A	1	WI
	RIJK-4-6-2000-FF	White	4	6	2	FF	2000	N/A	1	WI

Laser Sheets

Part #	Diagram Number	Width	Length	Labels / Sheet	Sheets / Pack	Approx Wt / Case	Radius Corners	Labels / Pack	Stocking Locations
--------	----------------	-------	--------	----------------	---------------	------------------	----------------	---------------	--------------------

EDP Laser Sheets, Permanent Adhesive, Also Compatible with Ink Jet Printers

RL-1-1-80	1	1	1	80	100	26	No	8000	OH	10 business days
RL-15-05-100	2	1.5	0.5	100	100	26	No	10,000	OH	
RL-15-1-50-RC	3	1.5	1	50	100	26	Yes	5000	OH	10 business days
RL-175-05-80-RC	4	1.75	0.5	80	100	26	Yes	8000	OH	
RL-175-1-44	5	1.75	1	44	100	26	No	4400	OH	10 business days
RL-25-1563-18-RC	6	2.5	1.563	18	100	26	Yes	1800	OH	
RL-2625-1-30-RC	7	2.625	1	30	100	26	Yes	3000	OH	10 business days
RL-2833-1-33	8	2.833	1	33	100	26	No	3300	OH	
RL-2833-1375-24	9	2.833	1.375	24	100	26	No	2400	OH	10 business days
RL-35-075-28-RC	10	3.5	0.75	28	100	26	Yes	2800	OH	
RL-4-1-20-RC	11	4	1	20	100	26	Yes	2000	OH	10 business days
RL-4-133-14-RC	12	4	1.33	14	100	26	Yes	1400	OH	
RL-4-15-12-RC*	13	4	1.5	12	100	26	Yes	1200	OH	10 business days
RL-4-175-12-RC	14	4	1.75	12	100	26	Yes	1200	OH	
RL-4-2-10-RC	15	4	2	10	100	26	Yes	1000	OH	10 business days
RL-4-333-6-RC	16	4	3.33	6	100	26	Yes	600	OH	
RL-4-5-4-RC	17	4	5	4	100	26	Yes	400	OH	10 business days
RL-425-1-22	18	4.25	1	22	100	26	No	2200	OH	
RL-425-15-14	19	4.25	1.5	14	100	26	No	1400	OH	10 business days
RL-425-2-10	20	4.25	2	10	100	26	No	1000	OH	
RL-425-275-8	21	4.25	2.75	8	100	26	No	800	OH	10 business days
RL-425-55-4	22	4.25	5.5	4	100	26	No	400	OH	
RL-85-35-3	23	8.5	3.5	3	100	26	No	300	OH	10 business days
RL-85-55-2	24	8.5	5.5	2	100	26	No	200	OH	
RL-85-11-1**	25	8.5	11	1	100	26	No	100	OH	

* Perfed vertically down center through face stock and liner. **Backscore

Circles, EDP Laser Sheets, Permanent Adhesive, Also Compatible with Ink Jet Printers

RL-1-C-63	26	1" Diam. Circle	63	100	26	Yes	6300	OH	10 business days
RL-15-C-24	27	1.5" Diam. Circle	24	100	26	Yes	2400	OH	
RL-25-C-12	28	2.5" Diam. Circle	12	100	26	Yes	1200	OH	

Fluorescent EDP Laser Sheets, Permanent Adhesive, Available in Red & Green

RL-2625-1-30-G	7	2.625	1	30	100	26	Yes	3000	OH	10 business days
RL-2625-1-30-R	7	2.625	1	30	100	26	Yes	3000	OH	
RL-4-2-10-G	15	4	2	10	100	26	Yes	1000	OH	
RL-4-2-10-R	15	4	2	10	100	26	Yes	1000	OH	
RL-4-333-6-G	16	4	3.33	6	100	26	Yes	600	OH	
RL-4-333-6-R	16	4	3.33	6	100	26	Yes	600	OH	
RL-85-11-1-G	25	8.5	11	1	100	26	No	100	OH	
RL-85-11-1-R	25	8.5	11	1	100	26	No	100	OH	
RL-166-CIR-24-G	29	1.66" Diam. Circle	24	100	26	No	2400	OH		
RL-166-CIR-24-R	29	1.66" Diam. Circle	24	100	26	No	2400	OH		
RL-25-CIR-12-G	28	2.5" Diam. Circle	12	100	26	No	OH	OH		
RL-25-CIR-12-R	28	2.5" Diam. Circle	12	100	26	No	OH	OH		

Shaded items have a lead time of ten business days.

Part #	Diagram Number	Width	Length	Labels / Sheet	Sheets / Pack	Approx Wt / Case	Radius Corners	Labels / Pack	Stocking Locations
--------	----------------	-------	--------	----------------	---------------	------------------	----------------	---------------	--------------------

Removable EDP Laser Sheets, Removable Adhesive

10 business days	RL-2625-1-30-REM	7	2.625	1	30	100	26	Yes	3000	OH
	RL-4-2-10-REM	15	4	2	10	100	26	Yes	1000	OH

Ultra Removable EDP Laser Sheets, Ultra Removable Adhesive

10 business days	RL-4-2-10-UR	15	4	2	10	100	26	Yes	1000	WI
	RL-4-5-4-UR	17	4	5	4	100	26	Yes	400	WI

Clear Polyester Laser Sheets, Permanent Adhesive

10 business days	RL-2625-1-30-CL	7	2.625	1	30	100	26	Yes	3000	OH
	RL-4-2-10-CL	15	4	2	10	100	26	Yes	1000	OH

White Polyester Laser Sheets, Permanent Adhesive

10 business days	RL-2625-1-30-WH	7	2.625	1	30	100	26	Yes	3000	OH
	RL-4-2-10-WH	15	4	2	10	100	26	Yes	1000	OH

Laser Drum Label (Vinyl), Permanent Adhesive

10 business days	RL-81875-1075-1-DR	30	8.1875	10.75	1	100	26	Yes	100	OH
------------------	--------------------	----	--------	-------	---	-----	----	-----	-----	----

8.5" X 14" EDP Laser Sheets, Permanent Adhesive

10 business days	RL-425-14-2 *	31	4.25	14	2	100	30	No	200	OH
	RL-4-6-4	32	4	6	4	100	30	No	400	OH
	RL-85-14-1**	33	8.5	14	1	100	30	No	100	OH

* Perfed horizontally at 7" through face stock and liner. ** Liner is backscored for easy removal.

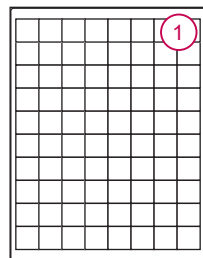

1 x 1
80 PER SHEET

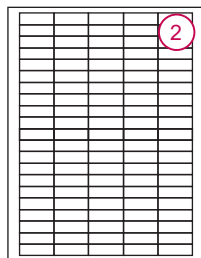

1 1/2 x 1/2
100 PER SHEET

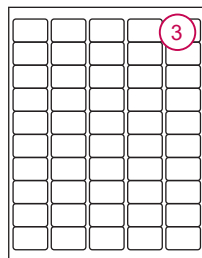

1 1/2 x 1
50 PER SHEET

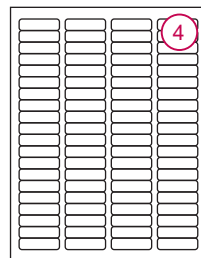

1 3/4 x 1/2
80 PER SHEET

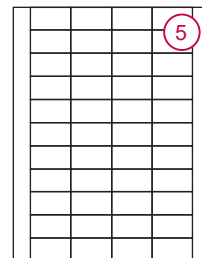

1 3/4 x 1
44 PER SHEET

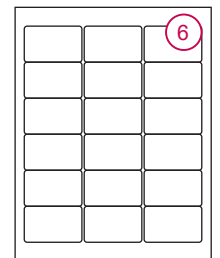

2 1/2 x 1 9/16
18 PER SHEET

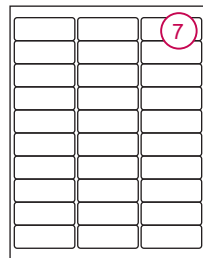

2 5/8 x 1
30 PER SHEET

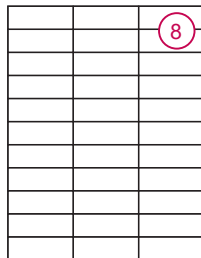

2.833 x 1
33 PER SHEET

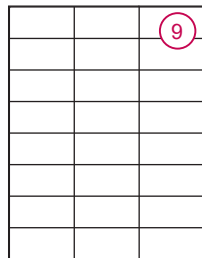

2.833 x 1 3/8
24 PER SHEET

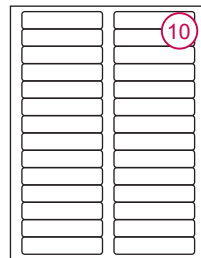

3 1/2 x 3/4
28 PER SHEET

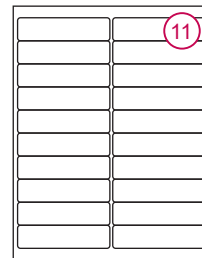

4 x 1
20 PER SHEET

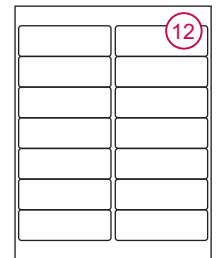

4 x 1.33
14 PER SHEET

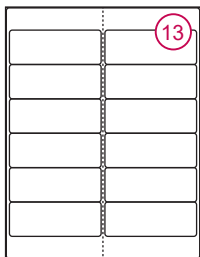

4 x 1 1/2
12 PER SHEET

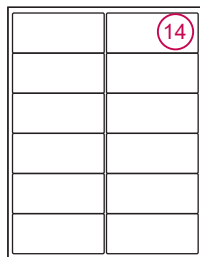

4 x 1 3/4
12 PER SHEET

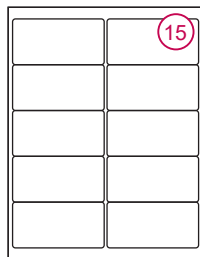

4 x 2
10 PER SHEET

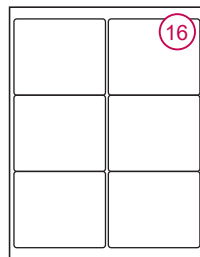

4 x 3 1/3
6 PER SHEET

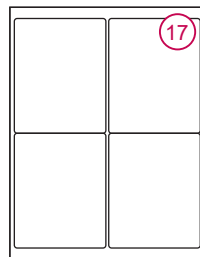

4 x 5
4 PER SHEET

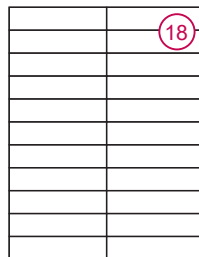

4 1/4 x 1
22 PER SHEET

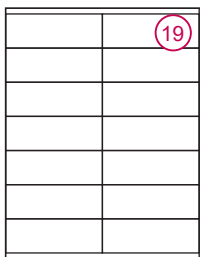

4 1/4 x 1 1/2
14 PER SHEET

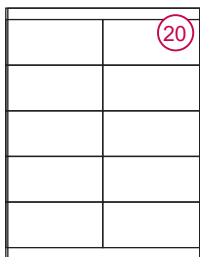

4 1/4 x 2
10 PER SHEET

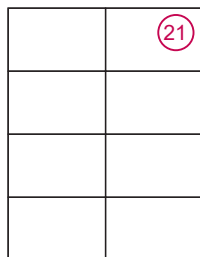

4 1/4 x 2 3/4
8 PER SHEET

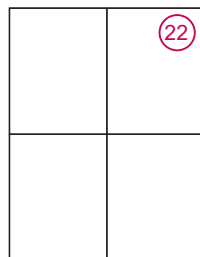

4 1/4 x 5 1/2
4 PER SHEET

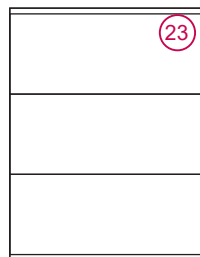

8 1/2 x 3 1/2
3 PER SHEET

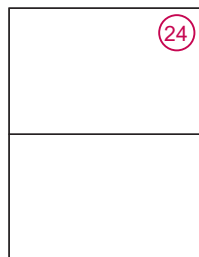

8 1/2 x 5 1/2
2 PER SHEET



8 1/2 x 11
1 PER SHEET

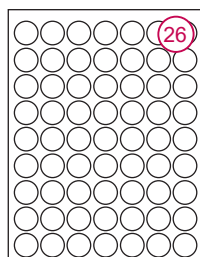

1" DIAMETER
63 PER SHEET

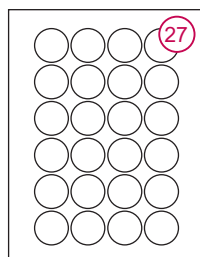

1 1/2" DIAMETER
24 PER SHEET

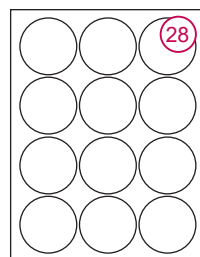

2 1/2" DIAMETER
12 PER SHEET

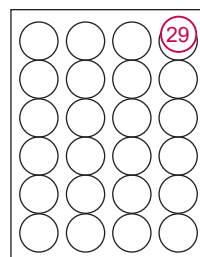

1.66" DIAMETER
24 PER SHEET

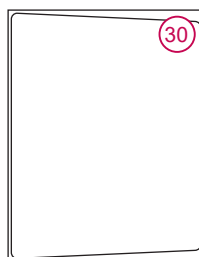

8 3/16" x 10 3/4"
1 PER SHEET

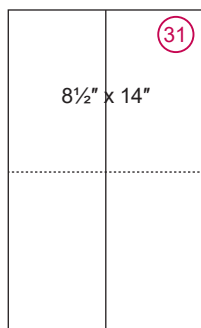

4 1/4 x 14
2 PER SHEET

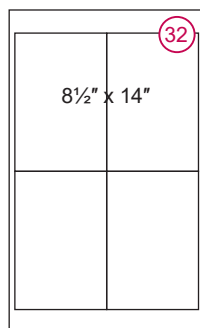

4 x 6
4 PER SHEET

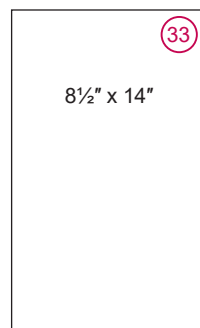

8 1/2 x 14
1 PER SHEET

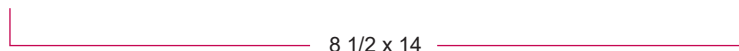

Please reference front of catalog for packaging specifications.

Integrated Label Sheets

Part #	Diagram Number	Label Width	Label Length	Labels / Sheet	Sheets / Case	Approx Wt / Case	Rounded Corners	Stocking Locations
--------	----------------	-------------	--------------	----------------	---------------	------------------	-----------------	--------------------

Preprinted Invoice, 8.5" x 11" White 24lb Bond Laser Sheet, Permanent Adhesive

RI-Invoice-1	1	4	6	1	1500	25	Yes	IL
--------------	---	---	---	---	------	----	-----	----

PMS Color: Reflex Blue

8.5" x 11" White 24 lb Bond Laser Sheet, Permanent Adhesive

RI-2-1-4	2	2	1	4	1500	21	No	IL
RI-2-1-8	3	2	1	8	1500	22	No	IL
RI-25-075-12	4	2.5	0.75	12	1500	23	No	IL
RI-25-125-2-Left	5	2.5	1.25	2	1500	23	Yes	IL
RI-25625-1-3	6	2.5625	1	3	1500	21	No	IL
RI-35-15-2	7	3.5	1.5	2	1500	22	No	IL
RI-35-2-1-Left	8	3.5	2	1	1500	22	Yes	IL
RI-35-2-1-Right	9	3.5	2	1	1500	22	Yes	IL
RI-35-2-2-RC	10	3.5	2	2	1500	23	Yes	IL
RI-35-275-2-RC	11	3.5	2.75	2	1500	23	Yes	IL
RI-35-275-2-NP	11	3.5	2.75	2	1500	23	Yes	IL
RI-4-25-1-Left	12	4	2.5	1	1500	23	Yes	IL
RI-4-25-1-Left-NP	12	4	2.5	1	1500	23	Yes	IL
RI-4-25-1-Right	13	4	2.5	1	1500	23	Yes	IL
RI-4-25-2-RC	14	4	2.5	2	1500	23	Yes	IL
RI-4-25-2-NP	14	4	2.5	2	1500	23	Yes	IL
RI-4-2875-2-RC	15	4	2.875	2	1500	23	Yes	IL
RI-4-6-1-Mail Order	16	4	6	1	1500	26	Yes	IL
RI-4125-4-1-Right	17	4.125	4	1	1500	24	Yes	IL
RI-6-4-1-RC	18	6	4	1	1500	24	Yes	IL
RI-6-4-1-Left	19	6	4	1	1500	24	Yes	IL
RI-6-4-1-Right	20	6	4	1	1500	24	Yes	IL
RI-6&2-4-2	21	6 & 2	4	2	1500	24	No	IL
RI-6&2-4-2-NP	21	6 & 2	4	2	1500	24	No	IL
RI-USPS-Click-N-Ship®	22	6.8125	4.75	1	1500	25	Yes	IL
RI-7-425-1-PAY-PAL	23	7	4.25	1	1500	25	No	IL
RI-75-5125-1-RC	24	7.5	5.125	1	1500	25	Yes	IL
RI-8-35-1-RC	25	8	3.5	1	1500	24	Yes	IL

Membership Cards, 8.5" x 11" White 80 lb Bond Laser Sheet, No Adhesive

RI-3375-2125-CARDS-2-FOLD	26	3.375	2.125	2	1000	35	Yes	IL
---------------------------	----	-------	-------	---	------	----	-----	----

8.5" x 14" White 24 lb Bond Laser Sheet, Permanent Adhesive

RI-2-1-4-14	27	2	1	4	1500	25	No	IL
RI-25-075-12-14	28	2.5	0.75	12	1500	27	No	IL
RI-35-15-2-14	29	3.5	1.5	2	1500	26	No	IL
RI-35-2-1-14Left	30	3.5	2	1	1500	26	Yes	IL
RI-35-2-1-14Right	31	3.5	2	1	1500	26	Yes	IL
RI-35-2-2-14RC	32	3.5	2	2	1500	27	Yes	IL
RI-4-25-1-14Right	33	4	2.5	1	1500	27	Yes	IL

Part #	Diagram Number	Label Width	Label Length	Labels / Sheet	Sheets / Case	Approx Wt / Case	Rounded Corners	Stocking Locations
--------	----------------	-------------	--------------	----------------	---------------	------------------	-----------------	--------------------

8.5" x 14" White 24 lb Bond Laser Sheet, Permanent Adhesive (continued)

RI-6-4-1-14Left	34	6	4	1	1500	30	Yes	IL
RI-6-4-1-14Right	35	6	4	1	1500	30	Yes	IL
RI-6&2-4-2-14	36	6 & 2	4	2	1500	30	No	IL

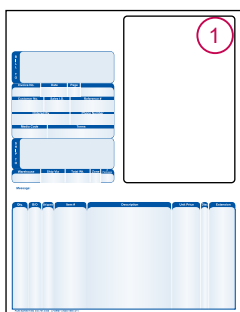

PREPRINTED INVOICE
4" x 6" - 1 UP Label is ¼" from top and ½" from right

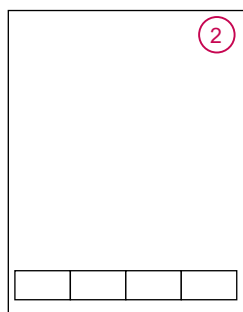

2" x 1" LABELS - 4 UP
Labels are ¼" from left & right, 5/8" from bottom

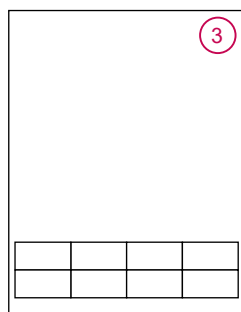

2" x 1" LABELS - 8 UP
Labels are ¼" from left & right, 5/8" from bottom

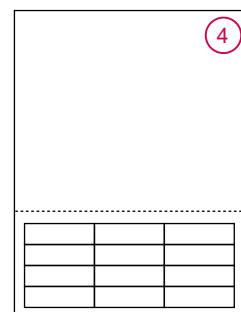

2 ½" x ¾" LABELS - 12 UP
Labels are 7/16" from left & right, 5/16" from bottom

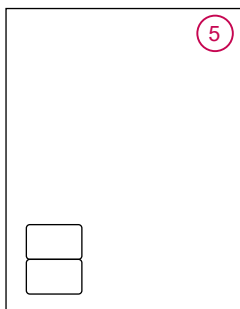

2 ½" x 1 ¼" LABELS - 2 UP
Labels are ¾" from left & ¾" from bottom

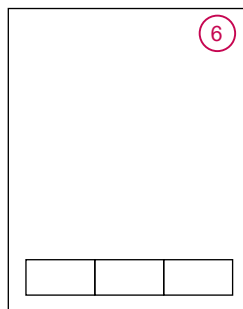

2 9/16" x 1" LABELS - 3 UP
Labels are 3/8" from left & right, 3/8" from bottom

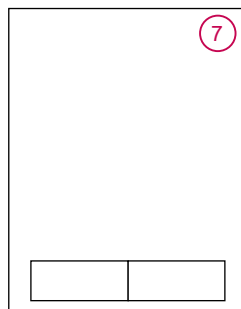

3 ½" x 1 ½" LABELS - 2 UP
Labels are ¾" from left & right, ½" from bottom

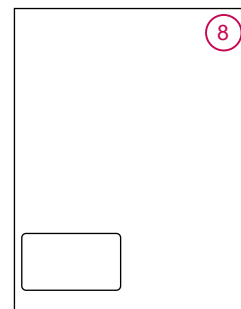

3 ½" x 2" LABEL - 1 UP
Label is ¼" from left & 7/8" from bottom

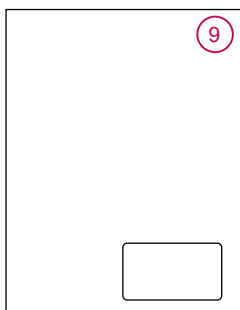

3 ½" x 2" LABEL - 1 UP
Labels are ¾" from right & 5/8" from bottom

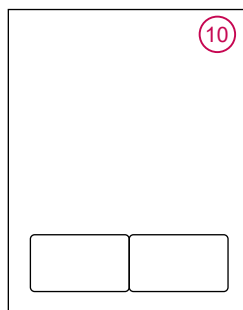

3 ½" x 2" LABELS - 2 UP
Labels are ¾" from left & right, 7/8" from bottom

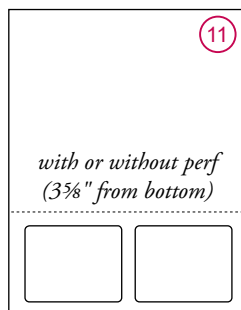

3 ½" x 2 ¾" LABELS - 2 UP
Labels are ½" from left & right & ½" between labels, 3/8" from bottom

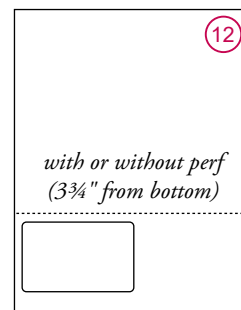

4" x 2 ½" LABEL - 1 UP
Label is ¼" from left & 7/8" from bottom

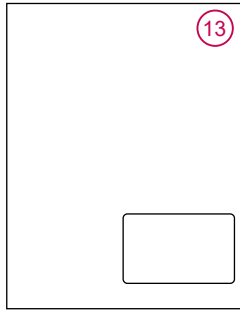

4"x 2½" LABEL - 1 UP
Label is ¼" from right
⅞" from bottom

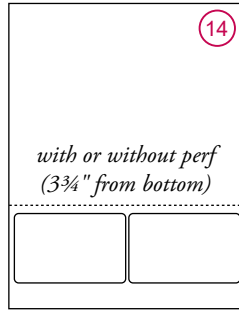

4"x 2½" LABELS - 2 UP
Labels are ⅜" from left & right
⅛" between labels, ⅞" from bottom

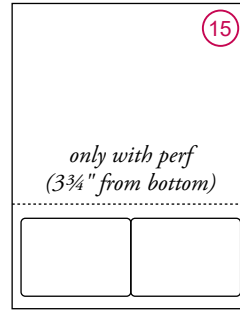

4"x 2⅛" LABELS - 2 UP
Labels are ¼" from left & right
⅜" from bottom

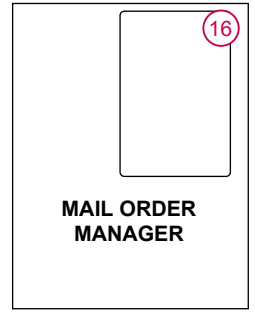

4"x 6" LABEL - 1 UP
Label is ½" from right
¼" from top

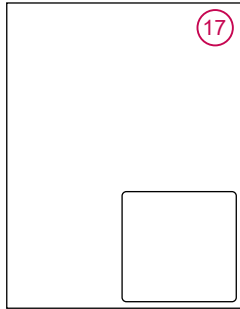

4⅛"x 4" LABEL - 1 UP
Label is ¼" from right
¼" from bottom

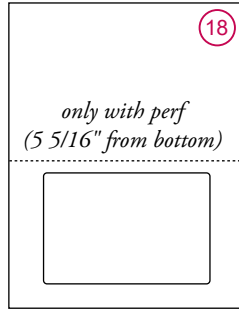

6"x 4" LABEL - 1 UP
Label is 1¼" from left & right
⅞" from bottom

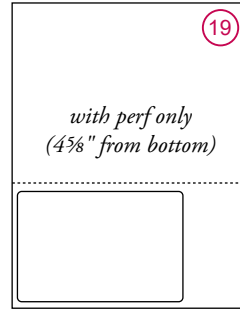

6"x 4" LABEL - 1 UP
Label is ⅞" from left
¼" from bottom

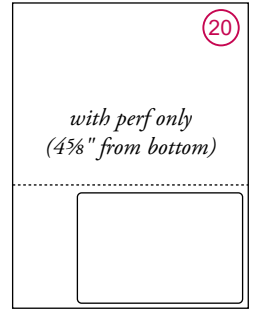

6"x 4" LABEL - 1 UP
Label is ⅞" from right
¼" from bottom

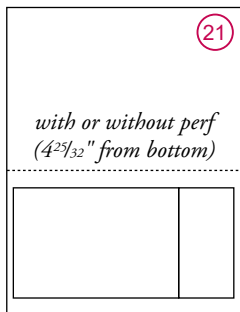

6" x 4" & 2" x 4" LABELS - 2 UP
Labels are ¼" from left
& right, ½" from bottom

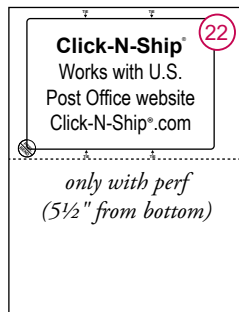

6 13/16" x 4 3/4" LABEL - 1 UP
Label is 9/16" from left
⅜" from top

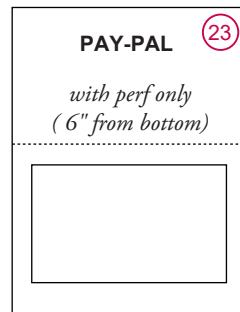

7"x 4¼" LABEL - 1 UP
Label is ¾" from left and right
1" from bottom

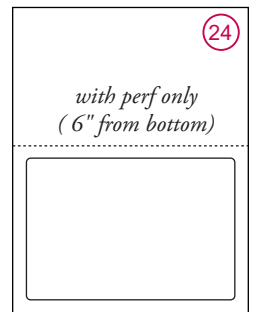

7½"x 5⅛" LABEL - 1 UP
Label is ½" from left & right
½" from bottom

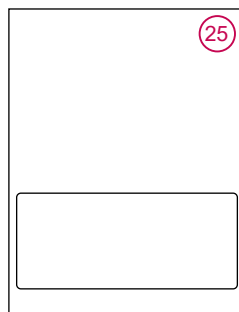

8"x 3½" LABEL - 1 UP
Label is ¼" from left & right
⅞" from bottom

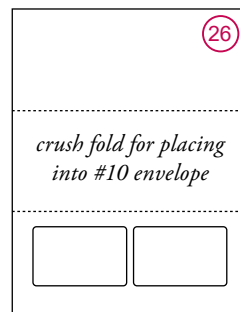

3⅜" x 2⅛" CARDS - 2 UP
Cards are ¼" from left
& right, 1" from bottom

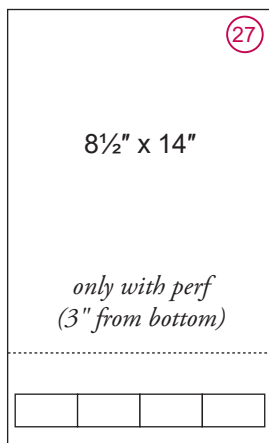

2" x 1" LABELS - 4 UP
Labels are 1/4" from left & right, 5/8" from bottom

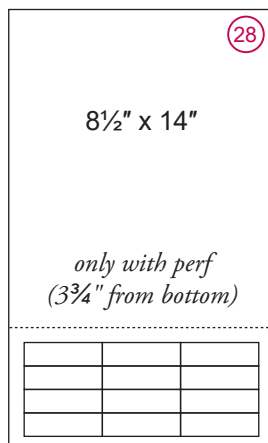

2 1/2" x 3/4" LABELS - 12 UP
Labels are 7/16" from left & right, 5/16" from bottom

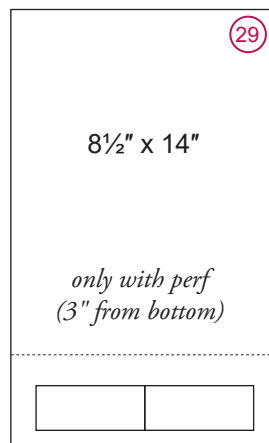

3 1/2" x 1 1/2" LABELS - 2 UP
Labels are 3/4" from left & right, 1/2" from bottom

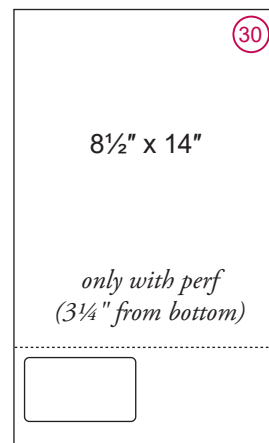

3 1/2" x 2" LABEL - 1 UP
Label is 1/4" from left & right, 7/8" from bottom

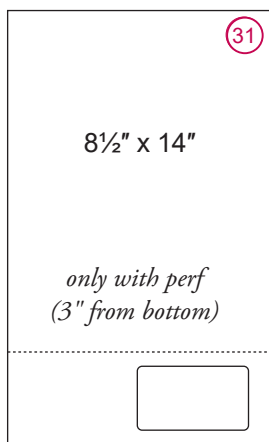

3 1/2" x 2" LABEL - 1 UP
Label is 3/4" from right, 5/8" from bottom

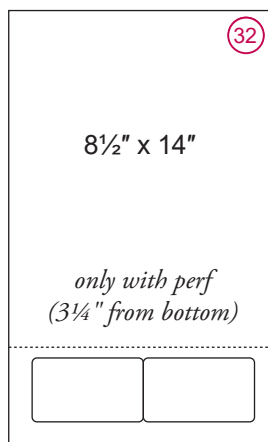

3 1/2" x 2" LABELS - 2 UP
Label are 3/4" from left & right, 7/8" from bottom

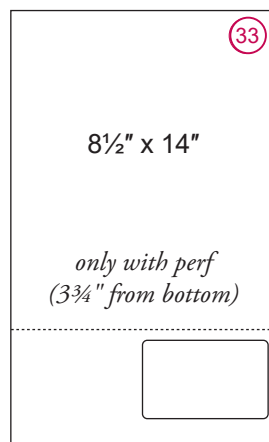

4 x 2 1/2" LABEL - 1 UP
Label is 1/4" from right, 7/8" from bottom

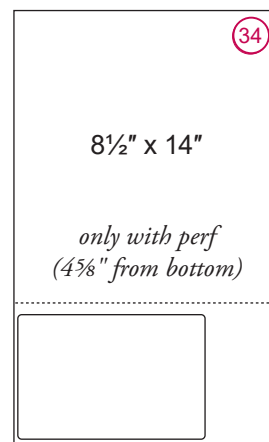

6" x 4" LABEL - 1 UP
Label is 1/8" from left, 1/4" from bottom

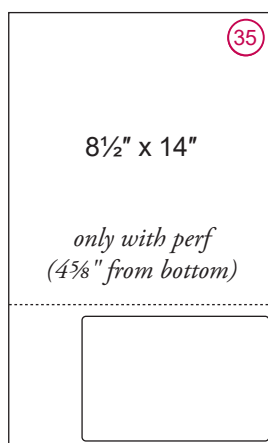

6" x 4" LABEL - 1 UP
Label is 1/8" from right, 1/4" from bottom

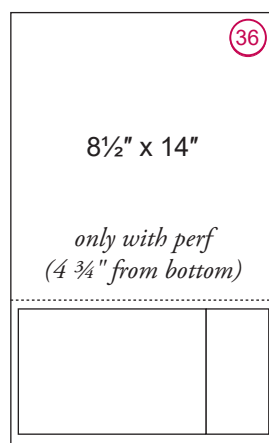

6" x 4" & 2" x 4" LABELS - 2 UP
Labels are 1/4" from left & right, 1/2" from bottom

Handling Labels

Width	Length	Number Up	Core Size	Labels / Roll	Approx Wt / Case	Rolls / Carton	Stocking Locations
-------	--------	-----------	-----------	---------------	------------------	----------------	--------------------

Thermal Transfer, Preprinted, Permanent Adhesive, 5" O.D., Perfed Each, Wound Out, 3" Core

10 business days

2	3	1	3	500	3	3	OH
---	---	---	---	-----	---	---	----

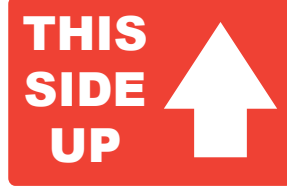

QC-2-3-500-UP
PMS 032 RED
ON WHITE

Thermal Transfer, Preprinted, Permanent Adhesive, 5" O.D., Perfed Each, Wound Out, 3" Core

10 business days

3	5	1	3	500	8	3	OH
---	---	---	---	-----	---	---	----



QC-3-5-500-GLASS

PMS 032 RED
ON WHITE



QC-3-5-500-FRAGILE

PMS 032 RED
ON WHITE



QC-3-5-500-LIQUID

PMS 032 RED
ON WHITE



QC-3-5-500-DROP

PMS 032 RED
ON WHITE

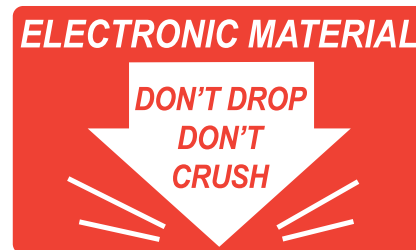

QC-3-5-500-CRUSH

PMS 032 RED
ON WHITE

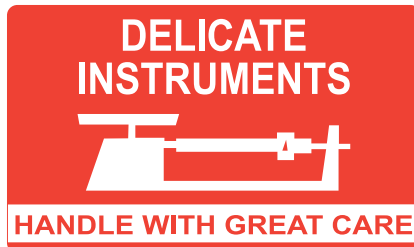

QC-3-5-500-DI1

PMS 032 RED
ON WHITE



QC-3-5-500-DI2

PMS 032 RED
ON WHITE

Inventory Control Labels

Width	Length	Number Up	Core Size	Labels / Roll	Approx Wt / Case	Rolls / Carton	Stocking Locations
-------	--------	-----------	-----------	---------------	------------------	----------------	--------------------

1 1/2" Circles, Thermal Transfer, Preprinted, 5" O.D., Perm Adhes, No Perf, Wound Out, 3" Core

1.5" Diam. Circle	1	3	1000	3.3	4	OH
-------------------	---	---	------	-----	---	----

10 business days



IP-15-CIR-0
PMS 345 GREEN
REVERSE



IP-15-CIR-1
PMS 032 RED
REVERSE



IP-15-CIR-2
BLACK ON
PMS 290 BLUE



IP-15-CIR-3
BLACK ON
PANTONE YELLOW



IP-15-CIR-4
PMA 424 GRAY
REVERSE



IP-15-CIR-5
PMS 1495 ORANGE
REVERSE



IP-15-CIR-6
PMS 265 PURPLE
REVERSE



IP-15-CIR-7
PMS 301 BLUE
REVERSE

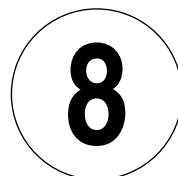

IP-15-CIR-8
BLACK ON
WHITE



IP-15-CIR-9
PMS 4705 BROWN
REVERSE



MP-15-CIR-SUN
PMS 032 RED
REVERSE



MP-15-CIR-MON
PMS 345 GREEN
REVERSE

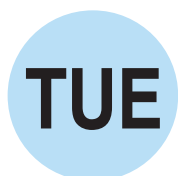

MP-15-CIR-TUE
BLACK ON
PMS 290 BLUE



MP-15-CIR-WED
BLACK ON
PANTONE YELLOW



MP-15-CIR-THUR
PMS 424 GRAY
REVERSE



MP-15-CIR-FRI
PMS 1495 ORANGE
REVERSE



MP-15-CIR-SAT
PMS 265 PURPLE
REVERSE

Shaded items have a lead time of ten business days.



MP-15-CIR-JAN
PMS 032 RED
REVERSE



MP-15-CIR-FEB
PMS 345 GREEN
REVERSE



MP-15-CIR-MAR
PMS 301 BLUE
REVERSE



MP-15-CIR-APR
PMS 1495 ORANGE
REVERSE



MP-15-CIR-MAY
MAGENTA
REVERSE



MP-15-CIR-JUN
BLACK ON
PANTONE YELLOW



MP-15-CIR-JUL
BLACK ON
PMS 1905 PINK



MP-15-CIR-AUG
BLACK ON
PMS 290 BLUE



MP-15-CIR-SEP
PMS 424 GRAY
REVERSE



MP-15-CIR-OCT
PMS 4705 BROWN
REVERSE



MP-15-CIR-NOV
PMS 345 GREEN
REVERSE



MP-15-CIR-DEC
PMS 265 PURPLE
REVERSE



QC-15-CIR-01
PMS 345 GREEN
REVERSE



QC-15-CIR-02
PMS 345 GREEN
ON WHITE



QC-15-CIR-03
BLACK ON
WHITE



QC-15-CIR-04
PMS 345 GREEN
REVERSE



QC-15-CIR-05
BLACK ON
PANTONE YELLOW



QC-15-CIR-06
PMS 032 RED
REVERSE



QC-15-CIR-07
PMS 345 GREEN
REVERSE



QC-15-CIR-08
BLACK ON
PANTONE YELLOW



QC-15-CIR-09
PMS 345 GREEN
REVERSE



QC-15-CIR-10
PMS 032 RED
REVERSED



QC-15-CIR-11
PMS 032 RED
REVERSE



QC-15-CIR-12
BLACK ON
PANTONE YELLOW



QC-15-CIR-13
BLACK ON
WHITE

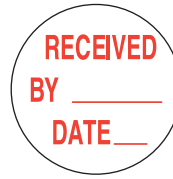

QC-15-CIR-14
PMS 032 RED
ON WHITE



QC-15-CIR-15
PMS 032 RED
REVERSED

Made in the U. S. A. Labels

Part #	Width	Length	Number Up	Core Size	Labels / Roll	Approx Wt / Case	Rolls / Case	Stocking Locations
--------	-------	--------	-----------	-----------	---------------	------------------	--------------	--------------------

Preprinted, Permanent Adhesive, 5" O.D., Perfed Each, Wound Out, 3" Core

QC-15-CIR-500-USA	1.5	1.5	1	3	500	3	3	OH
QC-2-3-500-FLAG	2	3	1	3	500	3	3	OH
QC-3-5-500-STATES	3	5	1	3	500	11	4	OH
QC-3-5-500-STARS	3	5	1	3	500	11	4	OH

10 business days



QC-2-3-500-FLAG
RED & BLUE ON WHITE



QC-15-CIR-500-USA
4-COLOR PROCESS



QC-3-5-500-STATES
4-COLOR PROCESS



QC-3-5-500-STARS
4-COLOR PROCESS

Shaded items have a lead time of ten business days.

Label Accessories

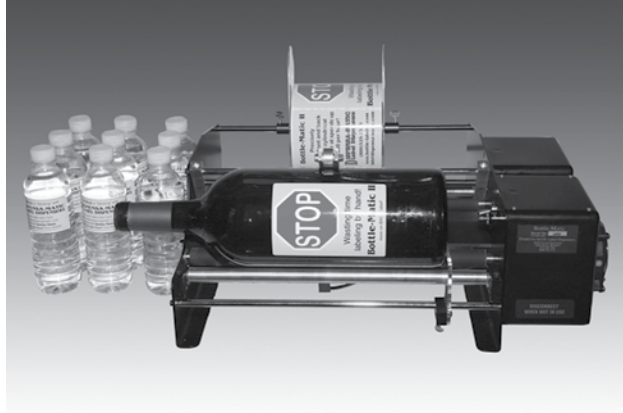

Bottle-Matic (Single Label)

- 10" width
- 16" width

Bottle-Matic II (Label Front and Back)

- 10" width
- 16" width

10" or 16" width Cylinder labeling machine. Label any cylindrical object fast and accurately from .5" to 8" diameter at speeds of 1200 pieces per hour! Bottle-Matic is the perfect machine for labeling your cylindrical objects! It can wrap your bottles, cans, tubes, and jars by simply pressing the foot switch! The Bottle-Matic can even label tapered objects without customizing.

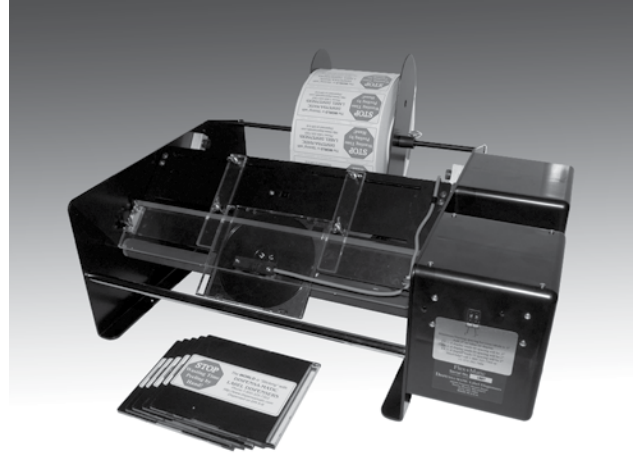

Flex+Matic

- 16" width

Flex+Matic is a 16" width flat labeling machine. Label any flat object fast and accurately up to 1/4" thick at speeds up to 1000 pieces per hour!

Flex+Matic is the perfect machine for labeling your flat objects! Label envelopes, plastic bags (even bags with zippers), CD cases, PCBs, unfilled flexible packaging, and so on. Simply insert your flat object into the machine, adjust guides for vertical placement, and then adjust digital circuit for horizontal placement. Flex+Matic requires 7/8" from the leading edge to the start of the label.

Zebra 105SL

Zebra 105SL Direct Thermal-Thermal Transfer Barcode Printer (203 dpi, 4.09 Inch Print Width, 8 ips Print Speed, Serial and Parallel Interfaces, 6MB DRAM and 2MB Flash) combines enhanced memory, processing capacity and features rugged all-metal construction. Proven platform longevity plus fast processing and print speed make it the choice of experienced users who value reliability, productivity, consistent print quality, network compatibility, and superior service and support.



GLU-100 Unwind

- Simple to Operate
- Industrial Strength
- Auto Speed Control
- Unwind Speed up to 24" / sec
- Label Widths from 1" to 9"
- Winds Labels In or Out

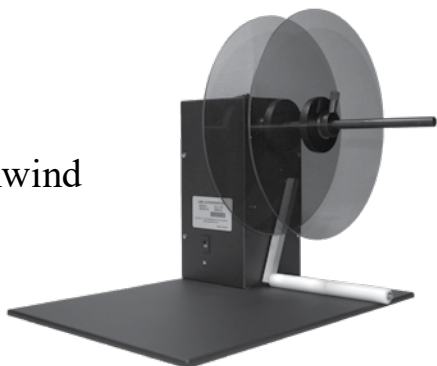

GLR-100 Rewind

- Simple to Operate
- Industrial Strength
- Auto Speed Control
- Rewind speed up to 24" / sec
- Label Widths from 1" to 9"
- Winds Labels In or Out



GLR-50 Label Rewinder

- Auto Speed Control
- Label Widths from 1" to 4"
- Winds Labels In or Out
- Standard 3" Core Holders
- 8" Diam Outer Disks
- Auto-Switching Universal Power Supply
- Direct & Thermal Transfer Printers



Dispensa-matic U-45

Dispensa-matic U-45 power advance for one-up computer forms or printed labels in rolls 3/8" to 4 1/2" wide.



Dispensa-matic U-60

Dispensa-matic U-60 power advance for larger labels in rolls up to 6" wide.



Simple Simon 4" width

Simple Simon 3 3/8" width manually operated, precision made metal dispenser for all types of roll labels...even thin ones.



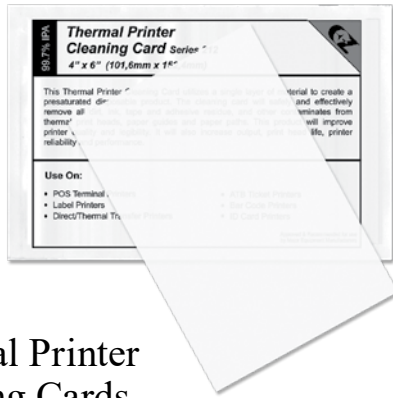

Thermal Printer Cleaning Cards

Part # TPHCC-2-6 2" x 6"

Part # TPHCC-4-6 4" x 6"

25 / box, all sizes.

Forms Press' Cleaning Cards are conveniently presaturated with 99.99% Anhydrous Isopropanol to allow maximum effectiveness with minimal effort. Only Forms Press' Cards preform preventive maintenance and corrective maintenance. Also available for linerless label printers, pouched with a different solution.



Thermal Printer Cleaning Wipes

100 / box Part # KK

Forms Press' Cleaning Wipes are soft, fibrous, and super-saturated with 99.99% Isopropyl Alcohol. Tear open and wipe the heads, label path and other areas for your thermal printer or other equipment. Safe, easy, effective and economical.

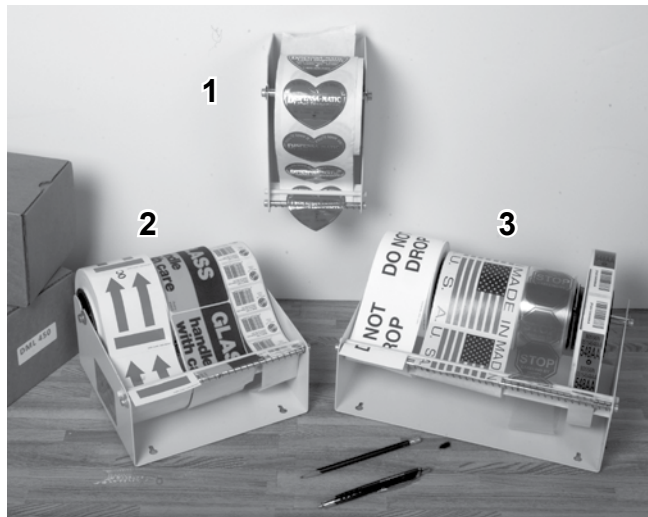

DML Series

1) DML 450

2) DML 850

3) DML 1250

DML 450 comes with 1 set of 3" core adapters
 DML 850 comes with 2 sets of 3" core adapters
 DML 1250 comes with 3 sets of 3" core adapters

6.5" maximum roll diameter. Additional 3" core adapters available for \$2.00 each.



Thermal Printer Cleaning Pens

Thermal Printer Cleaning Pens 12 / box

Part # CP-J

Use on printers with easily accessible print heads. Forms Press' Cleaning Pens are filled with 99.99% Isopropyl Alcohol, and can be used multiple times. Simply swipe across the print head a few times and you're finished. To clean the soft pen tip, swipe it across a clean sheet of paper. The capillary wicking action keeps the alcohol flowing to the pen tip. Our pen's tip cannot be jammed up the pen's body, thereby preventing you from accidentally damaging your print head. Safe and easy to use.

Forms Press' Portfolio of Products



Stock Labels & Tags

Nobody carries more stock labels! Forms Press offers one of the largest selections of stock labels in the industry. Choose from our stock imprints or create a custom imprint using our stock labels.



Custom Labels & Tags

When it comes to customized labels, Forms Press does it all. We offer custom configurations, core sizes, inks, materials, varnishes, multi-laminates and adhesives to satisfy your needs.



RFID Enabled Labels & Tags

Our proprietary printing process allows us to produce up to 8-color RFID enabled labels with accuracy and low rejection rates. Offering standard as well as custom solutions for a wide range of RFID applications.



Digital Label Short to Long Runs

Short to medium label runs with no plate or tooling charges--cut your labels any shape or size without tooling! Our long run digital press combines high speeds with rapid job change digital technology.



Variable Printing & Barcoding

In the age of traceability, everyone wants a code or mark. Forms Press offers digital and high speed, high resolution black variable print. Print variable 2D and 3D barcodes, QR codes, numbers, text and halftones.



UL Approved Labels

Forms Press participates in the Authorized Label Supplier Program for UL Certification Marks. Forms Press converts blank and custom 4-color process printed UL Approved Labels.



Flexible Packaging

Forms Press' flexible packaging encompasses stand-up pouches, flat bottom pouches and pillow pouches, bags, bar wraps, sachets, and stick packs. Make an impression by printing a different design on each bag.



Shrink Sleeves

Shrink sleeves offer a 360° canvas, maximizing marketing space for product information, graphics and branding. We offer full body shrink sleeves, combo packs and tamper evident perforated sleeves.



Wide Format Digital Printing

Forms Press' wide format digital presses can run roll-to-roll formats that include posters, banners, backlit signs, fine art, billboards, and decals. Rigid media formats include signs, exhibits and displays.



Thermal Transfer Ribbons

Black, color, flexible packaging and super solvent resistant ribbons— Forms Press offers a wide range of thermal transfer ribbons from which to choose!



forms
PRESS
INC.